

# JVC

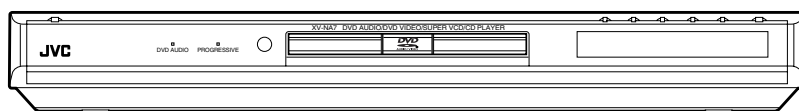

## DVD AUDIO/VIDEO PLAYER

# XV-NA7SL



## INSTRUCTIONS

Introduction	2
Getting started	6
Basic operations	15
Advanced operations	27
MP3 disc playback	47
JPEG disc playback	51
Changing the initial settings	57
Additional information	69

# Warnings, Cautions and Others

## IMPORTANT for the U.K.

**DO NOT** cut off the mains plug from this equipment. If the plug fitted is not suitable for the power points in your home or the cable is too short to reach a power point, then obtain an appropriate safety approved extension lead or consult your dealer.

BE SURE to replace the fuse only with an identical approved type, as originally fitted.

If nonetheless the mains plug is cut off ensure to remove the fuse and dispose of the plug immediately, to avoid a possible shock hazard by inadvertent connection to the mains supply. If this product is not supplied fitted with a mains plug then follow the instructions given below:

## IMPORTANT.

**DO NOT** make any connection to the terminal which is marked with the letter E or by the safety earth symbol or coloured green or green-and-yellow.

The wires in the mains lead on this product are coloured in accordance with the following code:

Blue : Neutral  
Brown : Live

As these colours may not correspond with the coloured markings identifying the terminals in your plug proceed as follows:

The wire which is coloured blue must be connected to the terminal which is marked with the letter N or coloured black.

The wire which is coloured brown must be connected to the terminal which is marked with the letter L or coloured red.

**IF IN DOUBT - CONSULT A COMPETENT ELECTRICIAN.**

## CAUTION

To reduce the risk of electrical shocks, fire, etc.:

1. Do not remove screws, covers or cabinet.
2. Do not expose this appliance to rain or moisture.

## Caution — ⏻ switch!

Disconnect the mains plug to shut the power off completely. The ⏻ switch in any position does not disconnect the mains line. The power can be remote controlled.

## CAUTION

- Do not block the ventilation openings or holes. (If the ventilation openings or holes are blocked by a newspaper or cloth, etc., the heat may not be able to get out).
- Do not place any naked flame sources, such as lighted candles, on the apparatus.
- When discarding batteries, environmental problems must be considered and local rules or laws governing the disposal of these batteries must be followed strictly.
- Do not expose this apparatus to rain, moisture, dripping or splashing and that no objects filled with liquids, such as vases, shall be placed on the apparatus.

## Caution: Proper Ventilation

To avoid risk of electric shock and fire and to protect from damage. Locate the apparatus as follows:

- Front: No obstructions and open spacing.  
Sides: No obstructions in 3 cm from the sides.  
Top: No obstructions in 5 cm from the top.  
Back: No obstructions in 15 cm from the back  
Bottom: No obstructions, place on the level surface.

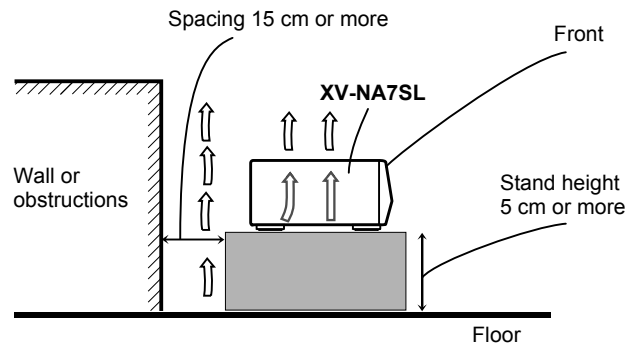

## IMPORTANT FOR LASER PRODUCTS

### REPRODUCTION OF LABELS

① CLASSIFICATION LABEL, PLACED ON REAR ENCLOSURE

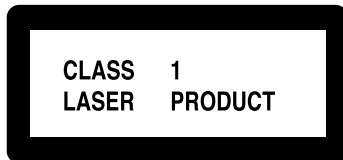

② WARNING LABEL, PLACED INSIDE THE UNIT

<b>CAUTION:</b> Invisible laser radiation when open and interlock failed or defeated. AVOID DIRECT EXPOSURE TO BEAM. (e)	<b>WARNING:</b> Osynlig laserstrålning när denna del är öppnad och spärren är urkopplad. Betrakta ej strålen. (s)	<b>ADVARSEL:</b> Usynlig laserstrålning ved åbning, når sikkerhedsafbrydere er ude af funktion. Undgå udsættelse for stråling (d)	<b>VARO:</b> Avattaessa ja suo- jalukitus ohitettaessa olet alttiina näkymättömälle lasersäteilylle. Älä katso säteeseen. (f)
--	---	---	---

1. CLASS 1 LASER PRODUCT
2. **CAUTION:** Visible and invisible laser radiation when open and interlock failed or defeated. Avoid direct exposure to beam.
3. **CAUTION:** Do not open the top cover. There are no user serviceable parts inside the Unit; leave all servicing to qualified service personnel.

# Table of Contents

<b>Introduction</b>	Page 2
<b>Supplied accessories</b> .....	2
<b>Notes on handling</b> .....	3
Important cautions.....	3
Safety precautions.....	3
<b>About discs</b> .....	4
Playable disc types.....	4
Non-playable discs.....	4
Audio formats.....	4
Disc structure.....	5
SVCDs and Video CDs with Playback Control function.....	5
Care and handling of discs.....	5
<b>Getting started</b>	Page 6
<b>Connections</b> .....	6
Before making any connections.....	6
To connect to a TV.....	6
To connect to a stereo audio amplifier/receiver.....	10
To connect to an amplifier/receiver equipped with 5.1-channel inputs.....	11
To connect to a digital audio device.....	12
To connect the power cord.....	12
<b>Using the remote control unit</b> .....	13
To install batteries in the remote control unit.....	13
Remote sensor.....	13
To use the remote control unit for TV operation.....	14
To control the volume of a JVC's amplifier or receiver.....	14
<b>Basic operations</b>	Page 15
<b>Before operation</b> .....	15
Turning on/off the unit.....	15
Initial setup before using the unit.....	16
<b>Basic playback</b> .....	18
Inserting and removing discs.....	18
To start playback.....	19
To stop playback completely.....	19
To stop playback temporarily.....	20
<b>Resuming playback</b> .....	20
To memorize the interrupt position.....	20
To resume playback.....	21
<b>Variable speed playback</b> .....	22
To advance or reverse playback rapidly while monitoring.....	22
To advance a still picture frame by frame.....	22
To playback in slow-motion.....	23
<b>To locate the beginning of the scene or song</b> .....	23
To locate a desired selection using ◀◀ or ▶▶.....	23
To locate a desired selection using the numeric buttons.....	24
<b>Other convenient functions</b> .....	25
To check the playback status.....	25
To move back the playback position during DVD VIDEO playback [One touch replay function].....	26
To change the brightness of the display window.....	26
<b>Advanced operations</b>	Page 27
<b>Playing from a specific position on a disc</b> .....	27
To locate a desired scene from the DVD menu.....	27
To locate a desired scene from the menu of a SVCD/Video CD with PBC.....	27
To specify a desired title/group.....	28
To locate a desired position in the current title, group or track [Time search].....	29
To locate a specific scene from the display [DIGEST].....	30
To select a still picture on a DVD AUDIO disc [PAGE].....	31
To play back a bonus group of a DVD AUDIO disc.....	31
<b>Changing the playback order</b> .....	32
To playback in a specific order [Program play].....	32
To playback in random order [Random play].....	34

<b>Repeat playback</b> .....	34
To repeat the current selection or all tracks [Repeat playback].....	34
To repeat a desired part [A-B repeat playback].....	35
<b>Changing the language, sound and scene angle</b> .....	36
To select the subtitle language [SUBTITLE].....	36
To change the audio language or sound [AUDIO].....	37
To select a scene angle of DVD VIDEO [ANGLE].....	38
<b>Special picture playback and picture/sound effect</b> .....	39
To display continuous still pictures [STROBE].....	39
To zoom in or out pictures [ZOOM].....	40
To adjust the picture character [VFP].....	40
To simulate surround sound [3D PHONIC].....	41
<b>Checking the sampling frequency and bit rate</b> .....	42
<b>Menu bar functions</b> .....	43
To bring up the menu bar.....	43
Basic operation procedure.....	43
Menu bar functions for DVD AUDIO.....	44
Menu bar functions for DVD VIDEO.....	45
Menu bar functions for SVCD/Video CD/Audio CD.....	46

<b>MP3 disc playback</b>	Page 47
<b>About MP3 discs</b> .....	47
<b>Operations</b> .....	47
Basic operations.....	47
Selecting the desired Group and Track.....	48
Direct selection.....	49
Repeat playback.....	49
Checking the sampling frequency and bit rate.....	50

<b>JPEG disc playback</b>	Page 51
<b>About JPEG discs</b> .....	51
<b>Basic operations</b> .....	52
To see a desired picture.....	52
To zoom in or out the pictures [ZOOM].....	53
<b>To see pictures continuously [slide show mode]</b> .....	54
Playback features.....	54
Selecting the start point of the slide show.....	54
Repeat function.....	56

<b>Changing the initial settings</b>	Page 57
<b>Selecting preferences</b> .....	57
About the Preference display.....	57
How to set preferences.....	57
LANGUAGE menu.....	58
PICTURE menu.....	59
AUDIO menu.....	60
SPK.SETTING menu.....	61
OTHERS menu.....	62
<b>Making fine tuning for your speakers</b> .....	63
To set the speaker sizes.....	63
To set the delay time.....	64
To set the speaker level.....	64
<b>Limiting playback by children</b> .....	65
To set Parental Lock for the first time [PARENTAL LOCK].....	66
To change the settings [PARENTAL LOCK].....	67
To temporarily release the Parental Lock [PARENTAL LOCK].....	68

<b>Additional information</b>	Page 69
<b>Names of parts and controls</b> .....	69
Front panel.....	69
Display window.....	69
Rear panel.....	69
Remote control unit.....	70
<b>Troubleshooting</b> .....	71
<b>Frequently Asked Questions</b> .....	73
<b>Specifications</b> .....	74
<b>Appendix A: Country/Area code list for Parental Lock</b> .....	75
<b>Appendix B: Glossary</b> .....	76

## Supplied accessories

- Audio/video cable (Yellow/White/Red) (× 1)

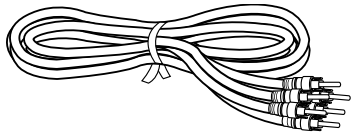

- Audio cable (White/Red) (× 2)

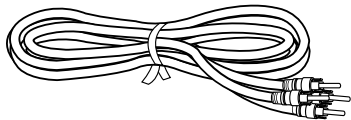

- Remote Control Unit (× 1)

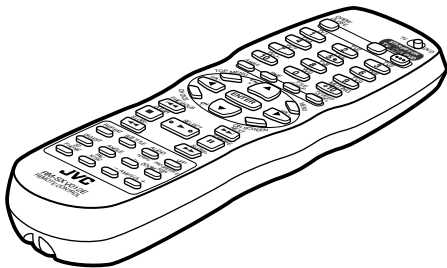

- R6P(SUM-3)/AA(15F) battery (× 2)

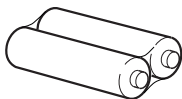

### About this instructions manual

In this instructions manual, we refer the terms in brackets [ ] to the display information and OSD (On Screen Display) menu. (Example: [AUDIO] means the AUDIO preference in the OSD menu.)

# Notes on handling

## Important cautions

### Installation of the unit

- Select a place which is level, dry and neither too hot nor too cold (between 5°C and 35°C, 41°F and 95°F).
- Leave sufficient distance between the unit and the TV.
- Do not use the unit in a place subject to vibrations.

### Power cord

- Do not handle the power cord with wet hands!
- A small amount of power (2.4 W) is always consumed while the power cord is connected to the wall outlet.
- When unplugging the unit from the wall outlet, always pull the plug, not the power cord.

### To prevent malfunction of the unit

- There are no user-serviceable parts inside. If anything goes wrong, unplug the power cord and consult your dealer.
- Do not insert any metallic object into the unit.
- Do not use any non-standard shape disc available on the market, because it may damage the unit.
- Do not use a disc with tape, seals, or paste on it, because damage to the unit may result.

### Note about copyright laws

- Please check the copyright laws in your country before recording from DVD AUDIO, DVD VIDEO, SVCD, Video CD, Audio CD, MP3 and JPEG discs. Recording of copyrighted material may infringe copyright laws.

### Note about the copyguard system

- DVD VIDEO discs are protected by the copyguard system. When you connect the unit to your VCR (or integrated TV/Video system), the copyguard system activates and the picture may not play back correctly.

## Safety precautions

### Avoid moisture, water and dust

Do not place the unit in moist or dusty places.

### Avoid high temperatures

Do not expose the unit to direct sunlight or place it near a heating device.

### When you are away

When you are away on travel or otherwise for an extended period of time, remove the plug from the wall outlet.

### Do not insert foreign objects into the unit

Do not insert wires, hairpins, coins, etc. into the unit.

### Do not block the vents

Blocking the vents may damage the unit.

### Care of the cabinet

When cleaning the unit, use a soft cloth and follow the relevant instructions on the use of chemically-coated cloths. Do not use benzene, thinner or other organic solvents and disinfectants. These may cause deformation or discoloring.

### If water gets inside the unit

Turn off the power switch and remove the plug from the wall outlet, then call the store where you made your purchase. Using the unit in this state may cause a fire or electrical shock.

This product incorporates copyright protection technology that is protected by method claims of certain U.S. patents and other intellectual property rights owned by Macrovision Corporation and other rights owners. Use of this copyright protection technology must be authorized by Macrovision Corporation, and is intended for home and other limited viewing uses only unless otherwise authorized by Macrovision Corporation. Reverse engineering or disassembly is prohibited.

Manufactured under license from Dolby Laboratories. "Dolby," "MLP Lossless" and the double-D symbol are trademarks of Dolby Laboratories.  
Confidential unpublished works.  
Copyright 1992-1998 Dolby Laboratories. All rights reserved.

Manufactured under license from Digital Theater Systems, Inc. US Pat. No. 5,451,942, 5,956,674, 5,974,380, 5,978,762, and other world-wide patents issued and pending. "DTS" and "DTS Digital Surround" are registered trademarks of Digital Theater Systems, Inc. Copyright 1996, 2000 Digital Theater Systems, Inc. All Rights Reserved.

## About discs

### Playable disc types

Playable and non-playable disc types are as follows:

<b>DVD AUDIO</b>  <small>AUDIO™</small>	<b>DVD VIDEO</b>  <small>VIDEO™</small>	<b>SVCD</b>  <small>COMPACT DISC SUPER VIDEO</small>
<b>Video CD</b> <b>Video CD</b>  <small>COMPACT DISC DIGITAL VIDEO</small>		<b>Audio CD</b>  <small>COMPACT DISC DIGITAL AUDIO</small>

The DVD Logo is a trademark.

- CD-R and CD-RW discs recorded in the SVCD, Video CD, Audio CD, MP3 or JPEG format can be played back. However, some discs may not be played back because of the disc characteristics or recording conditions.  
Note that unfinalized discs cannot be played back.
- DVD-R discs recorded with the DVD VIDEO format can be played back. However, some discs may not be played back because of the disc characteristics or recording conditions.  
Note that unfinalized disc cannot be played back.
- DVD VIDEO players and DVD VIDEO discs have their own Region Code numbers. This unit can play back only DVD VIDEO discs whose Region Code numbers include "2."

Examples of playable DVD VIDEO discs:



The unit is compatible with the PAL and NTSC systems, and can play back discs whose Region Code numbers include number "2." You can select "NTSC" or "PAL" while using the NTSC/REMOTE/PAL switch on the rear panel (for details, see page 6).

### Non-playable discs

DVD-ROM, DVD-RAM, DVD-RW, DVD+RW, CD-ROM, PHOTO CD, CD-EXTRA, CD-G, CD-TEXT, SACD, MIX-MODE CD

- Playing back discs listed as "Non-playable discs" above may generate noise and damage speakers.
- This unit can play back audio signals recorded in CD-G, CD-EXTRA, CD-TEXT and MIX-MODE CD discs.

### Audio formats

Some audio formats used on discs are described below.

- **Linear PCM**  
Uncompressed digital audio, the same format used on CDs and most studio masters.  
DVD AUDIO supports up to six channels at sample rates of 48/96/192 kHz (also 44.1/88.2/176.4 kHz) and sample sizes of 16/20/24 bits.  
DVD VIDEO supports two channels at sampling rates of 48/96 kHz and quantization of 16/20/24 bits.  
Audio CD/Video CD limited to two channels, 44.1 kHz at 16 bits.
- **MPEG Multichannel**  
A surround audio format which can handle the augmentative 7.1-channel format (rare for home use), as well as 5.1-channel.
- **Dolby Digital**  
A surround audio format configured with six channels. Because the "LFE (Low-Frequency Effect for sub-woofer, etc.)" channel, one of the six channels, is an auxiliary channel, this format is called "5.1-channel system."  
Not all Dolby Digital discs contain six (5.1) channel information.
- **DTS (Digital Theater Systems)**  
A surround audio format configured with six (5.1) channels which is same as Dolby Digital. Because the compression ratio is lower than Dolby Digital, it provides wider dynamic range and better separation.  
Not all DTS discs contain six (5.1) channels information.
- **MLP (Meridian Lossless Packing)**  
A format for DVD AUDIO with the compression ratio of about 2:1 while allowing the PCM signal to be completely recreated by the MLP decoder (required in all DVD AUDIO players). It supports up to 192 kHz/24 bit.

The associated indicator lights up in the display window when playing back a disc.

Indicator*	Audio format
LPCM	Linear PCM
MPEG	MPEG Multichannel
DOLBY DIGITAL	Dolby Digital
DTS	DTS (Digital Theater Systems)

\* When playing back a DVD AUDIO disc recorded by MLP (Meridian Lossless Packing; a lossless audio compression system that can completely recreate the PCM signal), no indicator lights up in the display window.

Note that with some formats and/or depending on the unit's [DIGITAL AUDIO OUTPUT] setting, digital audio signals may not be always transmitted from the unit's DIGITAL OUT jacks as they are recorded on the disc. See [DIGITAL AUDIO OUTPUT] on page 60 for details.

## Disc structure

### (For DVD AUDIO)

A DVD AUDIO disc is comprised of "groups," and each group is comprised of "tracks." Some DVD AUDIO discs also contain a "bonus group" that can be played back by entering the "key number" (a kind of password). Usually the contents of a "bonus group" are not opened to the public. Note that most DVD AUDIO discs include other information in addition to audio, such as still pictures, movies and text.

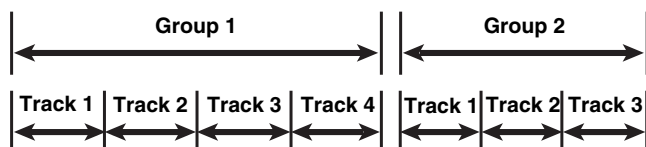

### (For DVD VIDEO)

A DVD VIDEO disc is comprised of "titles" and each title may be divided into "chapters." For example, if a DVD VIDEO disc contains some movies, each movie may have its own title number, and each movie may be divided into some chapters. In a DVD VIDEO KARAOKE disc, each song usually has its own title number and does not have chapters.

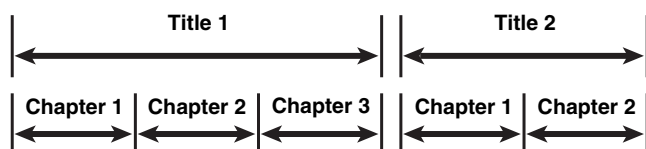

### (For SVCD/Video CD/Audio CD)

An SVCD, Video CD or Audio CD is simply comprised of "tracks."

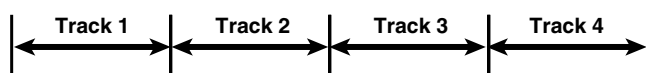

## SVCDs and Video CDs with Playback Control function

### What is Playback Control (PBC) function?

The Playback Control function allows you to enjoy menu-driven operation and high-resolution still images which have a resolution four times greater than moving pictures.

- **High-resolution still image display**  
You can display high-quality images four times clearer than moving pictures.
- **Menu-driven playback**  
A selection menu is displayed when you start playing a SVCD or Video CD disc with the Playback Control feature. The selection menu shows a list of numbers for selection. Some discs may show moving pictures or a divided screen.  
You can interact with the screen using the menu display to select and play an entry.  
See illustration below about basic feature of menu-driven playback (See page 27 for more information about PBC (Playback Control)).

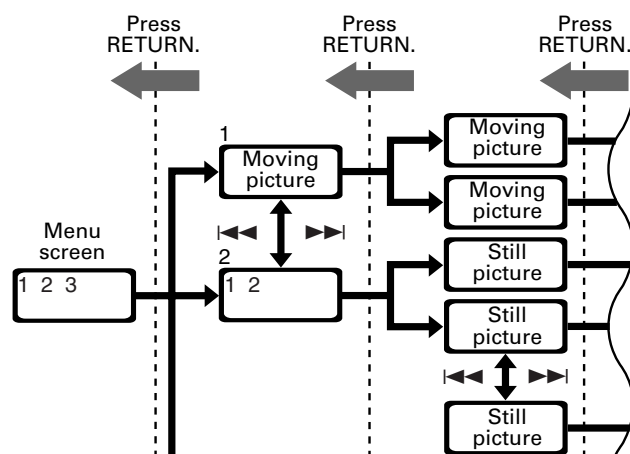

## Care and handling of discs

### How to handle discs

When handling a disc, do not touch the surface of the disc. Since discs are made of plastic, they are easily damaged. If a disc gets dirty, dusty, scratched or warped, the images and sound will not be picked up correctly, and such a disc may cause the player to malfunction.

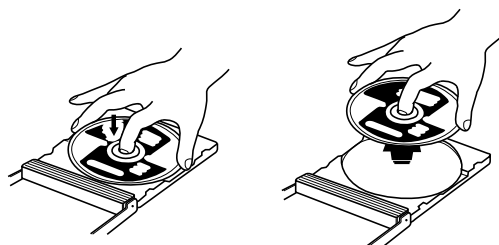

### Label side

Do not damage the label side, stick paper to or use any adhesive on its surface.

### Storage

Make sure that discs are kept in their cases. If discs are piled on top of one another without their protective cases, they can be damaged. Do not put discs in a location where they may be exposed to direct sunlight, or in a place where the humidity or temperature is high. Avoid leaving discs in your car!

### Maintenance of discs

If there are fingerprints or other dirt adhering to a disc, wipe with a soft dry cloth, moving from the center outwards.  
If a disc is difficult to clean, wipe with a cloth moistened with water. Never use record cleaners, petrol, alcohol or any anti-static agents.

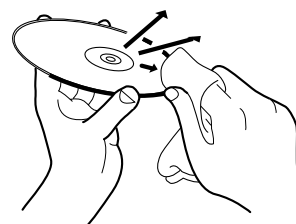

### CAUTION

The image may be sometimes poor or noisy due to defects in the disc itself.

## Connections

\*Before using the unit, you have to connect the unit to a TV and/or amplifier.

### Before making any connections

- Do not connect the AC power cord until all other connections have been made.
- Connect VIDEO OUT of the unit directly to the video input of your TV. Connecting VIDEO OUT of the unit to a TV via a VCR may cause a monitor problem when playing back a copy-protected disc. You may also have a monitor problem when connecting the unit to an integrated TV/Video system.

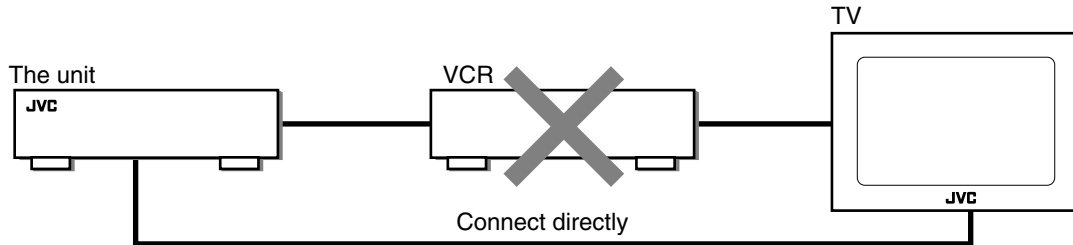

#### NOTES

- In the following description, "TV" may be substituted with "monitor" or "projector."
- Terminal names used for other components may be different from those used in the following description.

### To connect to a TV

#### Connection to a conventional TV

You can enjoy playback by simply connecting the unit to a TV.

Connect the unit to a TV equipped with stereo audio input and video input jacks using the supplied audio/video cables.

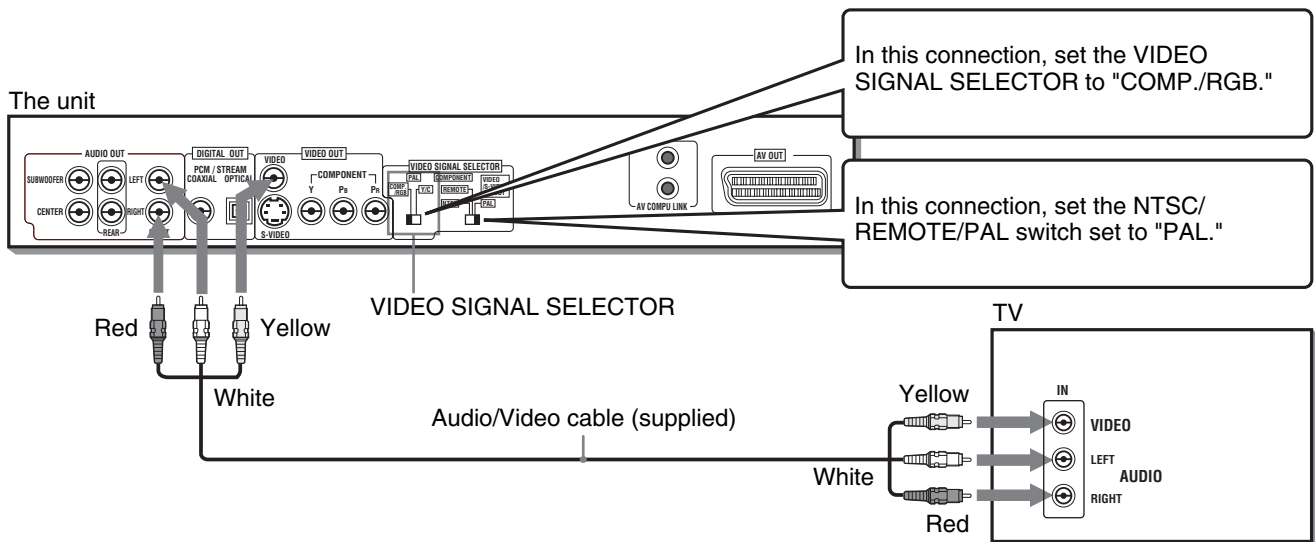

#### NOTE

- When you connect the unit to a TV with the VIDEO OUT (VIDEO or S-VIDEO) jacks or SCART connector, the unit outputs PAL signal only. If you connect the unit to a TV with these ways, make sure that the NTSC/REMOTE/PAL switch set to "PAL."



## Connection to a TV equipped with an S-video jack

If your TV has an S-VIDEO input, you can get better picture quality by connecting it with the S-VIDEO output of the unit using an S-video cable instead of connecting the video input of the TV to the VIDEO jack of the unit.

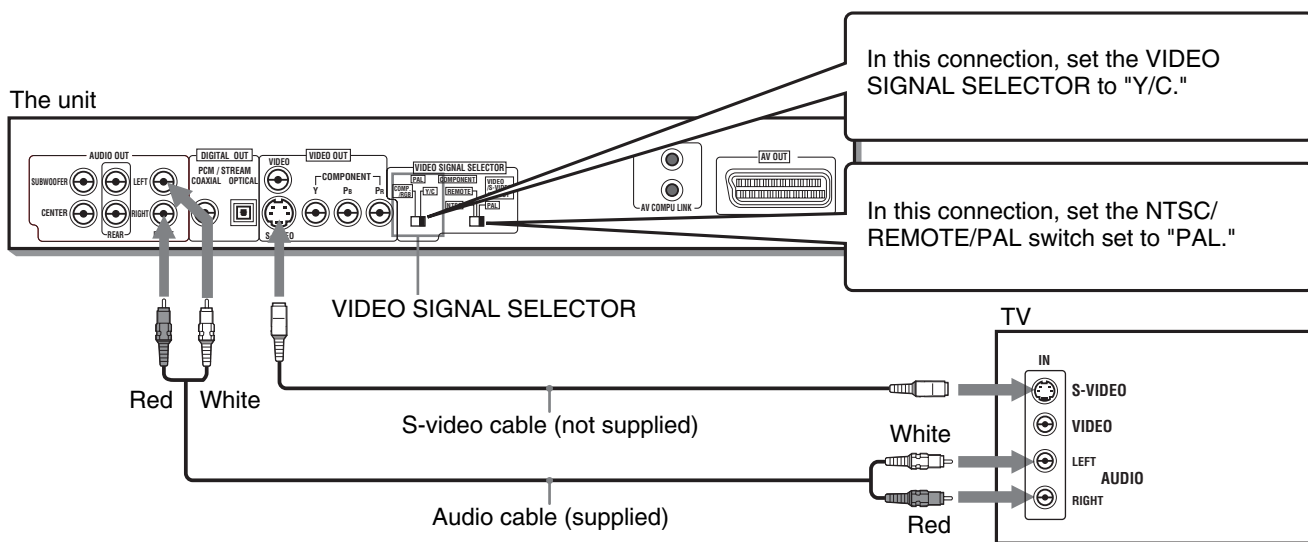

### NOTES

- Connect the unit to a PAL TV or multi-scan TV.
- Even if cables are connected to both the VIDEO OUT jack and S-VIDEO jack, video signal will only be transmitted from the port selected by the settings.
- You must change the switch position while the unit power is off. Otherwise, the changed setting is not effective.

## To connect to a TV with the SCART connector

You can enjoy using the unit by simply connecting it to your television set with a 21-pin SCART cable. To hear audio sound with better quality, connect the AUDIO output to your audio equipment.

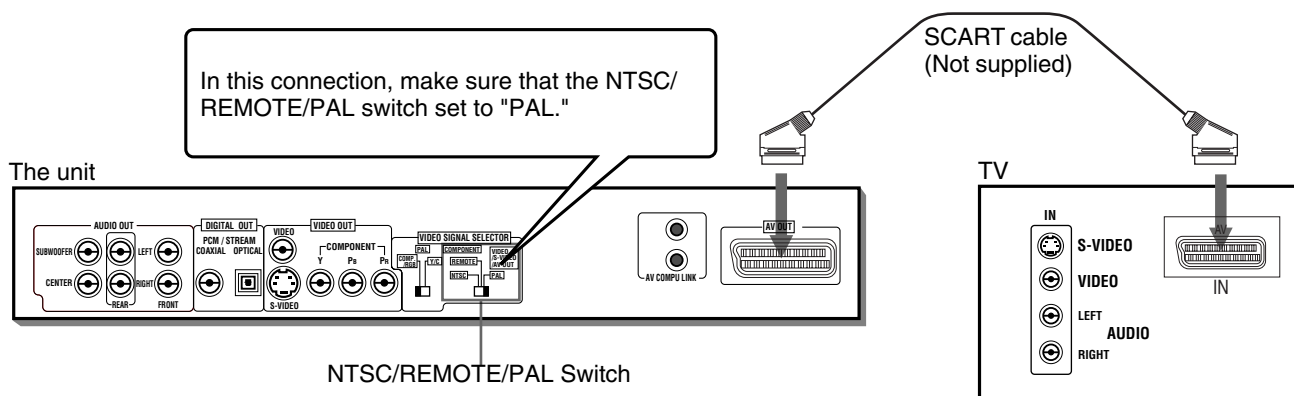

## Set the VIDEO SIGNAL SELECTOR correctly according to your TV

- If the TV only accommodates the composite video signal, set the switch to "COMP./RGB."
- If the TV accommodates Y/C signals, set the switch to "Y/C" so that you can enjoy better-quality pictures.
- If the TV accommodates RGB signals, set the switch to "COMP./RGB," and set the unit to supply RGB signals using the procedure shown below.

If you connect the unit to a PAL TV, set the NTSC/REMOTE/PAL switch to "REMOTE" and select PAL system from the remote control unit (see page 9).

## How to set the unit to supply RGB signals

The unit cannot output the RGB signals from the SCART connector and the S-video (Y/C) signals from the S-VIDEO jack simultaneously.

- When the unit is turned off

### 1 Set the VIDEO SIGNAL SELECTOR to "COMP./RGB."

Note that you must change the switch position while the unit power is off. Otherwise, the changed setting is not effective.

### 2 Turn the unit to on.

The RGB signal outputs from the SCART connector.

#### NOTES

- If you connect to a TV with the VIDEO OUT (VIDEO or S-VIDEO) jack, or the SCART connector, make sure that the NTSC/REMOTE/PAL switch set to "PAL."
- You must change the switch position on the rear panel while unit power is off. Otherwise, the changed setting is not effective.

## Connection to a TV equipped with component jacks

You can enjoy high picture quality by connecting the unit's COMPONENT VIDEO OUT jacks to the COMPONENT VIDEO IN jacks of your TV with the video cables.

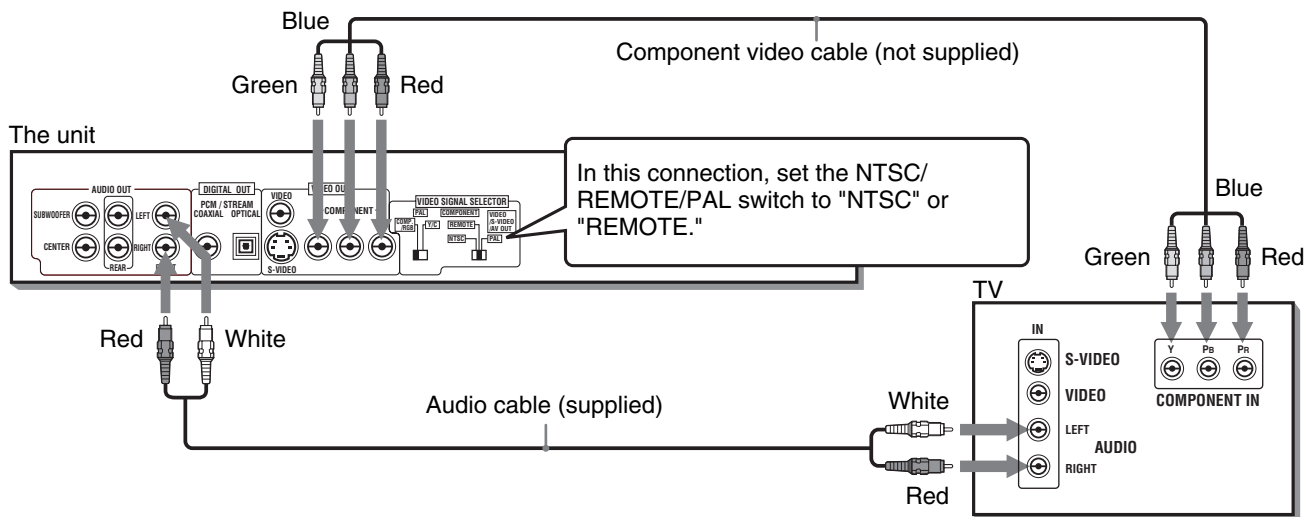

- Connect "Y" to "Y," "P<sub>B</sub>" to "P<sub>B</sub>"(C<sub>B</sub>), "P<sub>R</sub>" to "P<sub>R</sub>"(C<sub>R</sub>) correctly.

#### NOTES

- You must change the switch position on the rear panel while unit power is off. Otherwise, the changed setting is not effective.
- In this connection, make sure that the NTSC/REMOTE/PAL switch set to "NTSC" or "REMOTE."
- When the component video input jacks on the TV is of the BNC type, use an adapter to convert a pin jack to a BNC jack (optional).
- Set [ANALOG OUT] in the [AUDIO] preference display to [2-CH STEREO] (see page 60).
- If your TV has a monaural audio input instead of stereo, you need to use an optional audio cable which converts stereo audio output to monaural.
- To improve audio sound quality, connect the AUDIO OUT jacks to your separate audio equipment (see the following pages).

## To switch the signal format from the remote control unit

If you set the NTSC/REMOTE/PAL switch on the rear panel to "REMOTE," you can select the component signal format from the remote control unit.

- Before this operation, set the NTSC/REMOTE/PAL switch on the rear panel to "REMOTE," while the unit is turned off.

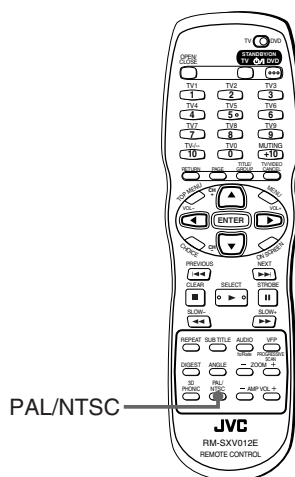

## Press and hold down the PAL/NTSC button

The signal format switches between the PAL and NTSC.

To check the current signal format, press PAL/NTSC button while the unit is turned on. The display window on the front panel shows the current status ([NTSC] or [PAL]).

### NOTES

- When switching the signal format from the remote control, make sure that the disc is stopped.
- You must change the switch position on the rear panel while unit power is off. Otherwise, the changed setting is not effective.
- If you set the NTSC/REMOTE/PAL switch on the rear panel is set to "REMOTE" or "NTSC," the unit output the signals from the COMPONENT VIDEO OUT jacks only.
- When you set the NTSC/REMOTE/PAL switch on the rear panel is set to "REMOTE," the VIDEO SIGNAL SELECTOR on the rear panel is not effective.

## About SCANNING MODE

To display video on the television (monitor) screen, the conventional scanning method is called "Interlaced scanning." With this method, only half of the horizontal lines are displayed at a time. So two fields complete a single picture (frame); i.e., the first field, containing all the odd-numbered lines, is displayed followed by the second field, containing all the even-numbered lines.

On the other hand, the Progressive scanning is resulting in flicker-free, high-density picture.

Depending on the material source format, DVD VIDEO discs can be classified into two types; film source and video source (note that some DVD VIDEO discs contain both film source and video source). Film sources are recorded as 24-frame-per-second information, while (NTSC) video sources are recorded as 30-frame-per-second (60-field-per-second interlaced) information.

When the unit plays back a film source material, uninterlaced progressive output signals are created using the original information. When a video source material is played back, the unit interleaves lines between the interlaced lines on each to create the interpolated picture and outputs as the progressive signal.

## To make the Progressive scanning mode selection active

The unit supports the Progressive scanning system as well as the conventional Interlaced scanning system. If your television or monitor supports the progressive video input, you can enjoy a high quality picture by making the Progressive scanning mode active.

The Progressive scanning mode selection only works when NTSC/REMOTE/PAL switch on the rear panel is set to "NTSC" or "REMOTE." However, note that, when the NTSC/REMOTE/PAL switch on the rear panel is set to "REMOTE" and set NTSC system from the remote control unit first.

- When the unit turned on, and the NTSC/REMOTE/PAL switch on the rear panel is set to "NTSC" or "REMOTE."

## Press and hold down VFP - PROGRESSIVE SCAN for a few seconds

The scanning mode switches between the Progressive scanning and Interlaced scanning modes.

- When the scanning mode is set to the progressive mode, the PROGRESSIVE indicator on the front panel is lit. Depending on the [STILL MODE] setting on the [PICTURE] preference display and whether the current DVD VIDEO disc is film-source or video-source, the color of the indicator differs, as shown in the table below. (see also page 59).

Setting of STILL MODE	Source type of DVD VIDEO		Note
	Film source	Video source	
FIELD	Red	Red	While stopped in the Progressive scanning mode, the PROGRESSIVE indicator is lit in red regardless of the [STILL MODE] selection.
FRAME	Green	Green	
AUTO	Green	Red	

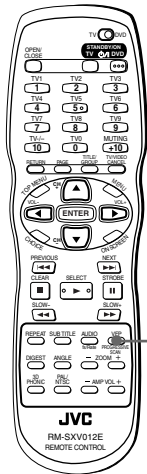

VFP-PROGRESSIVE SCAN

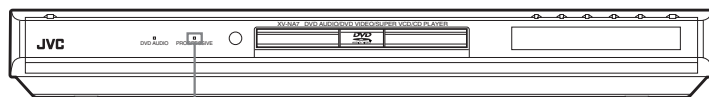

PROGRESSIVE indicator

Getting started

### NOTES

- The Progressive scanning mode works only when signal format is NTSC.
- The Progressive scanning mode works only when you connect to the unit's COMPONENT VIDEO OUT jacks.
- When you switch the signal format to PAL from the remote control unit, the Progressive scanning mode is canceled automatically.
- There are some progressive TV and High-Definition TV sets that are not fully compatible with the unit, resulting in the unnatural picture when playing back a DVD VIDEO disc in the Progressive scanning mode. In such a case, use the Interlaced scanning mode. To check the compatibility of your TV set, contact your local JVC customer service center.
- All JVC progressive TV and High-Definition TV sets are fully compatible with the unit (Example : AV-61S902).

## To connect to a stereo audio amplifier/receiver

You can enjoy high-quality audio by connecting the unit's audio output to your amplifier or receiver. Connect the unit's AUDIO OUT (LEFT/RIGHT) jacks to any line-level inputs (such as AUX, DVD, CD, etc.) of an audio amplifier or receiver.

The unit

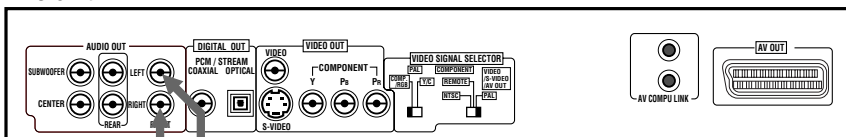

Red White

Audio cable (supplied)

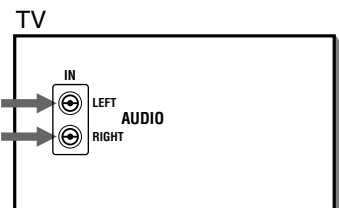

White  
Red  
LEFT  
RIGHT  
AUDIO

### NOTE

- When using the unit with a stereo amplifier or receiver, set [ANALOG OUT] in the [AUDIO] preference display to [2-CH STEREO] (see page 60).

## To connect to an amplifier/receiver equipped with 5.1-channel inputs

The unit supports the linear PCM multichannel format of DVD AUDIO and can feed multichannel audio output signals from the six analog AUDIO OUT jacks.

It is also equipped with the DTS and Dolby Digital decoders. So you can enjoy any type of the high quality surround sounds by connecting the unit to an amplifier/receiver equipped with the 5.1-channel inputs of an amplifier or receiver using the supplied audio cables.

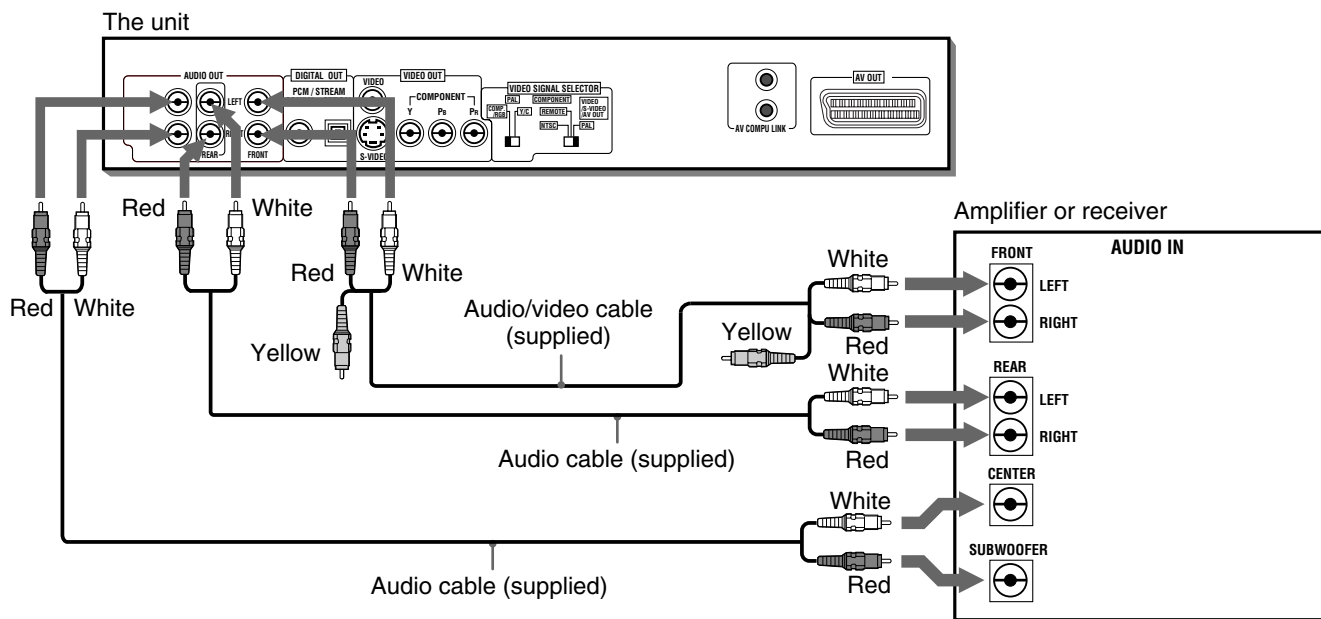

- Be sure to connect correctly between corresponding terminals. The order of the 5.1-channel terminals depend on units.

### NOTE

- When using the 5.1-channel outputs of the unit, set the [ANALOG OUT] in the [AUDIO] preference display to [MULTI CHANNEL] (see page 60). If you select [EXPERT] in the [SPK.SETTING] preference display, you can control the audio output balance of the speakers (see page 61).

## To connect to a digital audio device

You can enhance the playback sound quality by connecting either of the unit's DIGITAL OUT jacks to the digital input of an amplifier, etc. by using an optical or a coaxial digital cable (optional). The digital audio signal from a disc will be transferred directly. If you connect the unit to a Dolby Digital or DTS decoder or an amplifier with a built-in decoder using an optional digital cable, you can enjoy high-quality surround sound.

For a digital connection, connect the unit's DIGITAL OUT (OPTICAL or COAXIAL) to the digital input of a digital audio device using an optical or a coaxial digital cable.

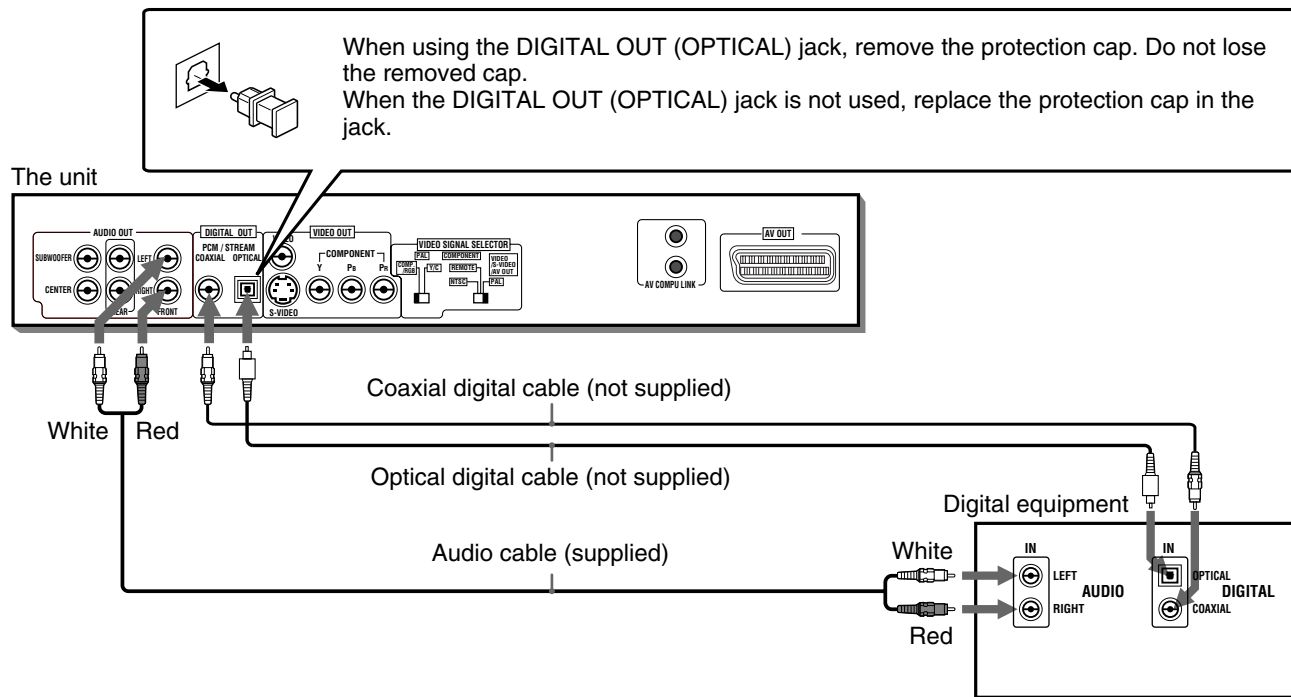

Note that the DIGITAL OUT jacks on the unit have been designed and equipped exclusively for enjoying the digital surround sound playback through the unit. It is not recommended to use the jacks for digital dubbing. When recording the sounds (DVD AUDIO, DVD VIDEO, SVCD, Video CD or Audio CD) played back on the unit, record them through the analog jacks (in this case, set [ANALOG OUT] in the [AUDIO] preference display to [2-CH STEREO]) (see page 60).

### NOTES

- When you make digital connection, we recommend also to make the analog connection, because, depending on discs, no signal may be output from the DIGITAL OUT.
- When you connect the unit's DIGITAL OUT to a digital audio device, before using, set [DIGITAL AUDIO OUTPUT] in the [AUDIO] preferences correctly according to the connected audio device. If [DIGITAL AUDIO OUTPUT] is not set correctly, loud noise may be generated from speakers, causing damage to them. See [DIGITAL AUDIO OUTPUT] on page 60.
- When you connect the unit's DIGITAL OUT to a Dolby Digital or DTS decoder (or amplifier with a built-in decoder) to enjoy surround sound, the unit's [D. RANGE COMPRESSION] setting in the [AUDIO] preferences is invalid. Make appropriate surround audio settings on the decoder.

## To connect the power cord

When all the audio/video connections have been made, insert the AC power plug to the wall outlet. Make sure that plugs are inserted firmly. The STANDBY/ON  $\odot$ /I button lights in red.

### Warning

- Disconnect the power cord if you are not going to use the unit for a long time.
- Disconnect the power cord before cleaning the unit.
- Disconnect the power cord before moving the unit.
- Do not connect or disconnect the power cord with wet hands.
- Do not pull the power cord when disconnecting it, as this may damage the cord and cause fire, electric shock, or other accidents.

### Caution

- Do not alter, twist or pull the power cord, or put anything heavy on it, which may cause fire, electric shock, or other accidents.
- If the cord is damaged, consult a dealer and have the power cord replaced with a new one.

## Using the remote control unit

Using the remote control, you can operate not only all the functions of the unit but also basic functions of your TV and amplifier/receiver.

### To install batteries in the remote control unit

The battery compartment is located on the back of the remote control unit.

- 1 Press down on the point shown by the arrow at the top of the compartment cover, and pull up the cover to open the compartment.



- 2 Place the two supplied R6P (SUM-3)/AA(15F) batteries in the remote control unit according to the polarity markings ("+" and "-") inside the compartment and on the batteries.

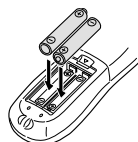

- 3 Place the cover over the compartment, and press down lightly.



The batteries will last about six months with normal use. If the functions of the remote control become erratic, replace the batteries. See below for more information.

### Precautions for the safe use of batteries

Observe the following precautions for the safe use of batteries. If they are used improperly their life will be shortened, they may burst or their contents may leak.

#### Precautions

- Remove the batteries from the remote control if it is not going to be used for a long period of time.
- Remove dead batteries and dispose of them properly.
- Never leave dead batteries lying around, take them apart, mix them with other refuse, or throw them into an incinerator.
- Never touch liquid that has leaked out of a battery.
- Do not mix new and old batteries, or batteries of different types, when replacing them.

### Remote sensor

- Operate the remote control unit while pointing it toward the remote sensor on the unit.
- The remote control unit can be used within a range of about 5 meters from the remote sensor. If you operate the remote control unit from a diagonal position, range may be shorter.

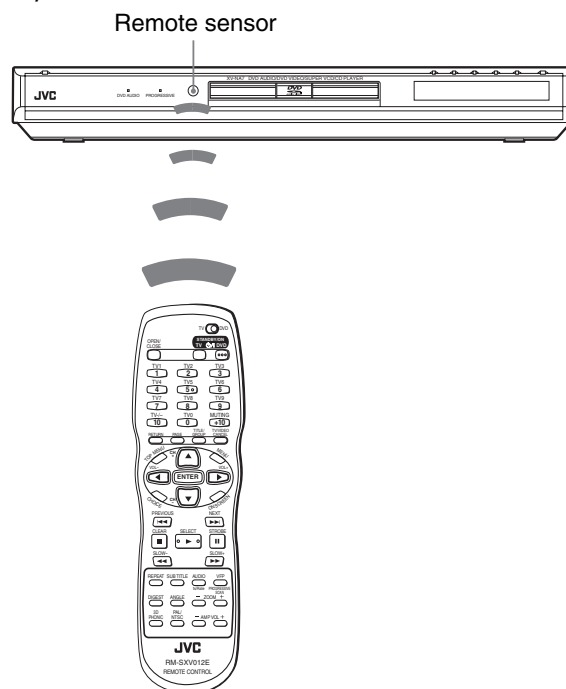

#### NOTE

- If the remote sensor on the unit is exposed to the sunshine or strong light, you may not be able to control the unit from the remote control unit.

## To use the remote control unit for TV operation

You can operate your TV from the remote control unit.

### Setting the remote control signal for operating your TV

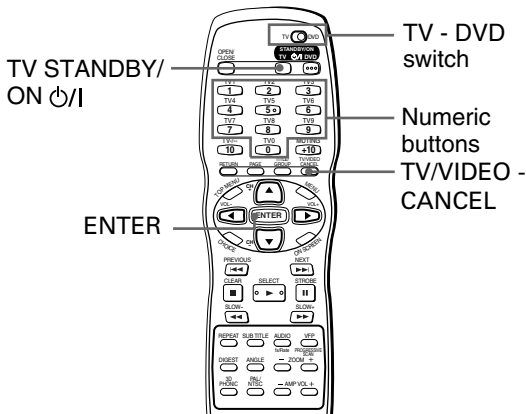

- 1 Set the TV - DVD switch to "TV."
- 2 Hold down TV/VIDEO - CANCEL until step 4 is finished.
- 3 Enter the manufacturer code of your TV listed below by using the numeric buttons (0 to 9).

Example:

To enter the manufacturer code "01": Press "0" then "1."



- When you purchased the unit, the manufacturer code is set to "JVC" (01).

- 4 Press ENTER.

#### Manufacturer code list

Manufacturer	No.	Manufacturer	No.
AIWA	36	MIVAR	29
BEIJING	22	NEC	20
CCE	02	NOBLEX	22
CHANGHONG	34	NOKIA	31
DAEWOO	17, 37	PANASONIC	04, 11
FERGUSON	27	PEONY	34, 38, 39
FINLUX	30	PHILCO	10, 17, 21
FUNAI	32	PHILIPS	02
GRADIENTE	15, 20	RCA	05
GRUNDIG	19	SAMSUNG	12, 33, 34, 35
HITACHI	10		
ITT	28	SANYO	13, 16
JINXING	38	SEARS	13
JVC	01, 23, 24, 25	SHARP	06
		SONY	07
KONKA	40	TCL	41
LG (GOLDSTAR)	18	THOMSON	26
MAGNAVOX	02	TOSHIBA	08, 14
MITSUBISHI	03	ZENITH	09

- 5 Release TV/VIDEO - CANCEL.
- 6 Try to operate the TV by pressing TV STANDBY/ON. If your TV turns on or off, you have successfully set the control signal.

The following buttons can be used for operating the TV.

To use ▲/▼ (CH+, CH-), ◀/▶ (VOL-, VOL+), TV/VIDEO - CANCEL and numeric buttons for TV control, set the TV - DVD switch to "TV."

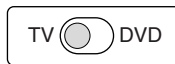

	<b>Turns the TV on or off.</b>
	<b>Switches the TV input mode between TV and VIDEO.</b>
	<b>Selects the TV channels directly.</b> * For some TVs, pressing "+10" functions as the "100+," while "10" functions as the ENTER button if your TV requires pressing the ENTER button after selecting a channel number.
	<b>Mutes the TV sound.</b>
	<b>Changes the TV channels.</b>
	<b>Adjusts the TV volume.</b>

#### NOTE

- If there is more than one code listed for the manufacturer of your TV, try them one by one until you succeed.

## To control the volume of a JVC's amplifier or receiver

You can control the volume of a JVC's amplifier or receiver by using the AMP VOL +/- buttons on the remote control unit.

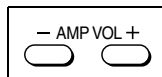

Pressing the + button raises the audio volume of the amplifier or receiver, while pressing the - button lowers the volume.



# Basic operations

In the following description, we assume that the buttons on the remote control unit are mainly used; however, you may use the corresponding buttons on the front panel if available.



## NOTE

TV  DVD

Make sure that the TV - DVD switch on the remote control unit is set to "DVD" when using the ▲/▼/◀/▶ and numeric buttons for controlling the unit.

## Before operation

### Turning on/off the unit

Press DVD STANDBY/ON  (on the remote control unit) or STANDBY/ON  (on the front panel).  
The STANDBY indicator on the STANDBY/ON  button, which lights in red during standby, lights in green.

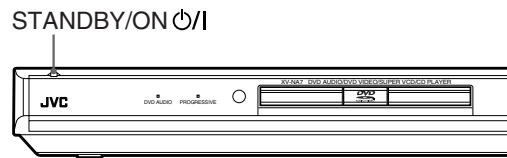
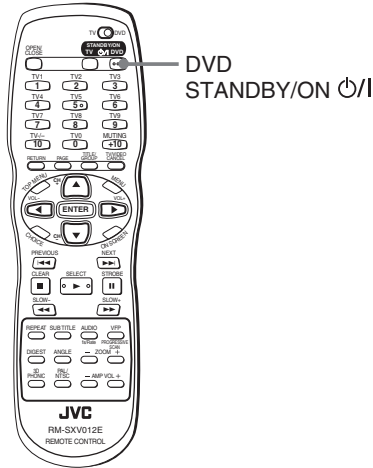

## Hints

- You can turn on the unit by pressing the ► button. In this case, the unit starts playback if the disc is set in the disc tray. If no disc is set, [NO DISC] appears on the display window.
- You can turn on the unit by pressing the ▲ button on the front panel. In this case, the disc tray opens.

The opening display shown at right appears on the TV screen.



The following messages may appear at the bottom of the opening display.

- NOW READING: The unit is reading the disc information.
- REGION CODE ERROR!: The region code of the DVD VIDEO disc does not match the unit. The disc cannot be played back.
- OPEN: The disc tray is opening.
- CLOSE: The disc tray is closing.
- NO DISC: No disc is loaded.
- RESUME STOP: The unit stops and memorizes the interrupted position.



Message area

## NOTE

- Even if you press the DVD STANDBY/ON  (on the remote control unit) or STANDBY/ON  (on the front panel) to turn off the unit, the unit is not disconnected from the AC power source as long as it is connected to the wall outlet. This state is called standby mode. In this state, the unit consumes a very small amount of power.

## Initial setup before using the unit

We recommend you to set the display language, TV monitor type, analog audio output and digital output before using the unit, by following the procedure below. When turning on the unit for the first time, the DVD PLAYER SET UP display automatically appears. In such a case, perform the following procedure from step 2. See "Changing the initial settings" beginning on page 57 for details about each setting item.

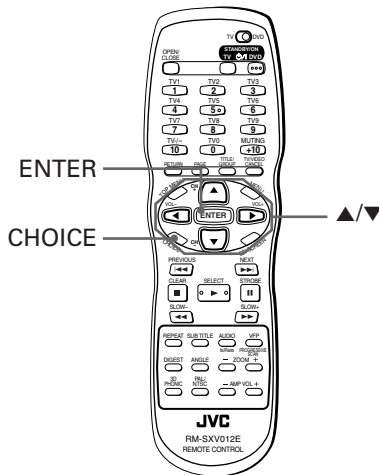

Basic operations

- 1 Press CHOICE for a few seconds to bring up the first page of the DVD PLAYER SET UP display.  
The pull-down menu of the [ON SCREEN LANGUAGE] is already open.

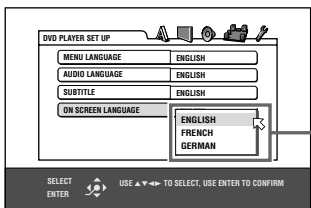

ON SCREEN LANGUAGE options

- 2 Use ▲/▼ to select a desired language.  
You can select the on-screen language for the preference displays, etc. from among English, French and German.

- 3 Press ENTER.  
The second page is shown, in which the pull-down menu of the [MONITOR TYPE] is already open.

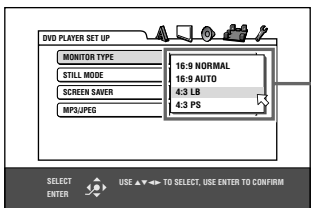

MONITOR TYPE options

- 4 Use ▲/▼ to select a desired monitor type.  
You can select the monitor type according to your TV.
  - For a normal (conventional) TV, select [4:3 LB] or [4:3 PS].
  - For a wide-screen TV, select [16:9 AUTO] or [16:9 NORMAL].
 See page 59 for details about each mode.

- 5 Press ENTER.  
The third (final) page is shown, in which the pull-down menu of the [ANALOG OUT] is already open.

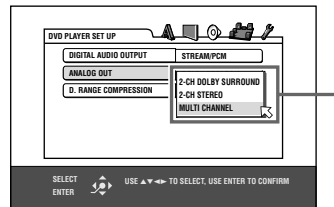

ANALOG OUT options

- 6 Use ▲/▼ to select a desired analog output signal type.  
You must set this item correctly when you play back a DVD VIDEO disc recorded with surround multichannel audio.
  - When connecting with a surround decoder, select [2-CH DOLBY SURROUND].
  - When connecting with a stereo amplifier/receiver or television set, select [2-CH STEREO].
  - When connecting the unit's 5.1-channel input, select [MULTI CHANNEL].

- 7 Press ENTER.  
The pull-down menu of the [DIGITAL AUDIO OUTPUT] appears.

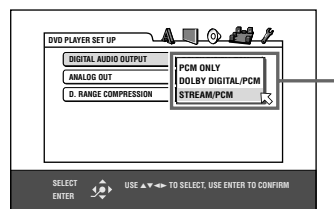

DIGITAL AUDIO OUTPUT options

## 8 Use ▲/▼ to select a desired digital output signal type.

You must set this item correctly when you connect the unit to an external surround decoder or D/A convertor (including an amplifier/receiver with built-in surround decoder or D/A convertor).

(If you do not connect the unit to such a device, you do not have to set this item.)

- When connecting with a Dolby Digital decoder, select [DOLBY DIGITAL/PCM].
- When connecting with a DTS or MPEG Multichannel decoder, select [STREAM/PCM].
- When connecting with other digital devices, select [PCM ONLY].

## 9 Press ENTER.

The TV screen returns to show the opening display.

### **NOTES**

- **This setting may not be necessary except when turning on the power after purchasing the unit.**
- **You can also set these items, as well as other preferences, by pressing CHOICE briefly to bring up the preference display. See "Changing the initial settings" on and after page 57 for details.**

# Basic playback

This section describes basic operations for playback of DVD AUDIO, DVD VIDEO, SVCD, Video CD and Audio CD discs. For MP3 and JPEG disc playback, see the separate chapter beginning on pages 47 and 51.

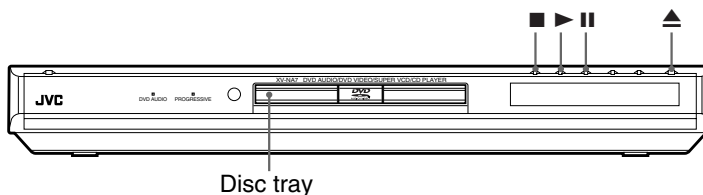
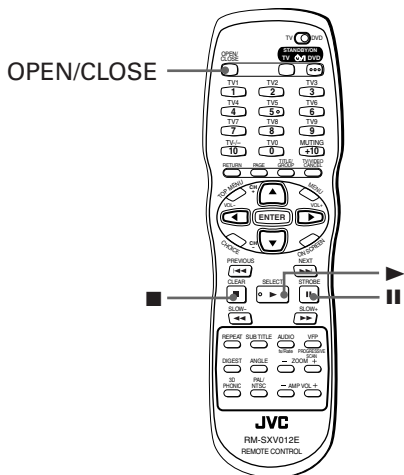

Basic operations

## Inserting and removing discs

- 1 Press to open the disc tray.
- 2 Place a disc in the disc tray.
- 3 Press to close the disc tray.  
The unit reads the disc information and the opening display appears on the TV screen.



- **If a menu is shown on the TV screen**  
When inserting a DVD AUDIO, DVD VIDEO, SVCD or Video CD disc, a menu display may be automatically shown on the TV screen. From the menu, you can select a desired item to be played back by following the procedure below.

**(for DVD AUDIO/DVD VIDEO)**

- 1 Use to select a desired item.
- 2 Press ENTER.  
The unit starts playback of the selected item.

**(for SVCD/Video CD)**

Use the numeric buttons to select a desired item.  
The unit starts playback of the selected item.

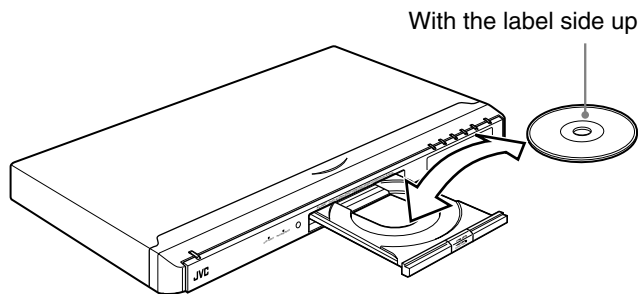

- To insert an 8-cm disc, place it in the inner recess.

### NOTES

- Do not load a non-playable disc. For details about playable and non-playable disc types, see page 4.
- When loading a disc on the disc tray, be sure to position the disc inside the recess. Otherwise, the disc may be damaged when the disc tray is closed, or you may not be able to remove the disc from the unit.
- Do not use any stabilizer when playing back a disc.
- With some DVD VIDEO discs, the unit starts playback automatically after inserting the disc.
- If you insert a DVD VIDEO disc whose region code does not match the unit, [REGION CODE ERROR!] is shown in the opening display. For details about the region code, see page 4.

## To start playback

Available :     

Press ►.

The unit starts playback from the beginning.



### About screen saver function

- A television monitor may have an image burned into it if a static image is displayed for a long time. To prevent this, the unit automatically activates the screen saver function if a static picture, such as an on-screen display or menu, is displayed for over 5 minutes.
- Pressing any buttons on the unit or the remote control unit will release the screen saver function and return to the previous display.
- You can also turn off the screen saver function (see page 59).
- The screen saver function does not work for still images during DVD AUDIO playback.

While the screen saver function is not activated









While the screen saver function is activated





### About On-screen guide icons

- When you make an operation, you may see the following icons displayed over the picture for about 3 seconds. These have the following meanings.

You can set the unit not to display these icons below via the preference settings described on page 62.

Icon	Status
	Appears at the beginning of playback mode.
	Appears at the beginning of pause mode.
	Appears at the beginning of fast forward/backward playback with the current speed (see page 22).
	Appears at the beginning of slow-motion playback with the current speed (see page 23).
	Appears at the beginning of a scene recorded from multiple angles (see page 38).
	Appears at the beginning of a scene recorded with multiple audio languages (see page 37).
	Appears at the beginning of a scene recorded with multiple subtitle languages (see page 36).

### About invalid operation icon

- When you press a button, if the unit does not accept its operation,  appears on your television screen. Operations are occasionally unacceptable even if  is not displayed.

Note that some operations may not be accepted. For example, some discs may not allow rapid advance/reverse or slow-motion playback.

### NOTES

- When the RESUME function is [ON] or [DISC RESUME] and a resume point is set, pressing ► starts playback from that point instead of the beginning. See page 21.
- During playback, the display window shows the title/chapter, group/track or track number being played.
- During DVD VIDEO playback, pressing ► moves the playback position back 10 seconds before the current position. See page 26 for details.

## To stop playback completely

Available :     

Press ■.

The unit stops playback.



- If you press ▲ during playback, the unit stops playback and opens the disc tray.

## To stop playback temporarily

Available :     

Press **II**.

The unit pauses playback. To resume playback, press **▶**.

## Resuming playback

The unit can memorize the position on a disc where you interrupt playback, and resume playback from that position later.

You can set two resume modes (DISC RESUME and ON) using the preference display. See page 62 for details about how to set the resume mode.



- The resume mode is initially set to [ON] when you purchased.
- You can deactivate the resume mode by setting [RESUME] on the [OTHERS] preference display to [OFF].

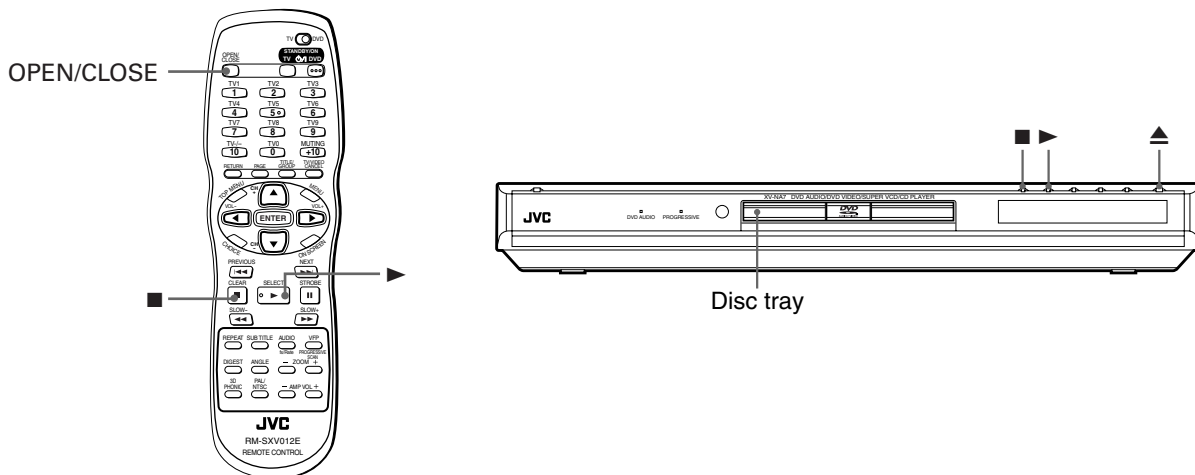

## To memorize the interrupt position

Available :    

- During playback

### When the resume mode is set to [DISC RESUME]

Press **■**.

The unit stops playback and memorizes the interrupt position. After pressing **■**, the display window on the front panel shows [RESUME STOP].

In this condition, the memory of the interrupt position is not cleared if you press **▲** to open the disc tray, or press STANDBY/ON **⏻** (on the front panel) or DVD STANDBY/ON **⏻** (on the remote control unit) to turn off the unit.



- The interrupt position is also memorized when you press **▲**, STANDBY/ON **⏻** (on the front panel) or DVD STANDBY/ON **⏻** (on the remote control unit). In this case, [RESUME STOP] is not shown on the display window.
- To clear the memory, press **■** while the disc stopped.
- The unit memorizes interrupt positions for the last 30 discs played.
- If you interrupt the playback of a disc for which an interrupt position has already been stored, the memory will be updated with the new interrupt position.
- After the unit has stored interrupt positions for 30 discs, remembering a new interrupt position will cause the unit to delete the oldest stored position. Interrupting playback of a disc for which an interrupt position is already stored may change the order in which the positions are stored. This may potentially change the order in which positions are deleted.

## When the resume mode is set to [ON]

Press ■ .

The unit stops playback and memorizes the interrupt position.

In this condition, the memory of the interrupt position is not cleared if you press STANDBY/ON  $\odot$ /I (on the front panel) or DVD STANDBY/ON  $\odot$ /I (on the remote control unit) to turn off the unit.

Note that if you press ▲ to open the disc tray, the memory of the interrupt position is cleared.



- The interrupt position is also stored by pressing STANDBY/ON  $\odot$ /I (on the front panel) or DVD STANDBY/ON  $\odot$ /I (on the remote control unit).
- To clear the memory, press ■ while the disc stopped.

## To resume playback

Available :

## When the resume mode is set to [DISC RESUME]

- While stopped, or no disc is inserted

- 1 Press ▲ to insert a disc for which the unit has stored an interrupt position.  
After loading the disc, the display window on the front panel shows [RESUME STOP].  
(If a disc for which you want to resume playback is already set in the disc tray, go to step 2.)



- 2 Press ►.

The display window shows [RESUME PLAY] and the unit resumes playback from the position where playback was interrupted.

The unit maintains the memory of the interrupt position for the disc, even if you remove the disc from the disc tray and replace it again. The unit also maintains the memory of the interrupt position while the disc is in the disc tray.

- **To play back a disc from the beginning (instead of the interrupted position)**  
After loading the disc, press ■ before pressing ► to start playback.  
Pressing ■ while the disc is stopped clears the memory of the interrupted position.  
Every time you interrupt playback, the position is remembered as the new "resume" point.

## When the resume mode is set to [ON]

- While the disc you interrupted playback last time\* is still on the disc tray (\*by pressing ■ or by turning off the power)

Press ►.

The unit resumes playback from the position where playback was interrupted.

If you press ► then ■, the unit starts playback after the display window shows [RESUME PLAY].

Note that you cannot resume playback if you interrupted playback last time by opening the disc tray.

- **To play back a disc from the beginning (instead of the interrupted position)**  
Do any of the following:
  - \* Press ■ while stopped, then press ►.
  - \* Turn on the unit by pressing DVD STANDBY/ON  $\odot$ /I (on the remote control unit) or STANDBY/ON  $\odot$ /I (on the front panel) then press ►.

### NOTES

- If you use the [OTHERS] preference display to change the [RESUME] setting from [DISC RESUME] to [OFF] or [ON], you cannot resume playback of a disc whose "resuming" position is stored. However, if you again set [RESUME] to [DISC RESUME], you will then be able to resume playback of the disc.
- If you open the disc tray while RESUME mode is set to ON, the "resume" point will be cleared.
- The resume function does not work with Audio CD, MP3 and JPEG discs.
- In the case of a SVCD/Video CD disc with PBC function, the unit may resume playback from a point slightly earlier or later than the point where playback was interrupted.
- The unit may not resume playback exactly from the interrupt point.
- For a double-sided DVD AUDIO/DVD VIDEO disc, the unit regards each side as a different disc. Therefore, to resume playback of such a disc, the disc must be loaded with the same side down.
- When the unit memorizes an interrupt point for a disc, it also remembers Audio, Subtitle and Angle settings (regardless of whether [RESUME] is set to [DISC RESUME] or [ON]).
- If you interrupt playback while the menu for a DVD AUDIO, DVD VIDEO, SVCD or Video CD is shown on the TV screen, the unit may not correctly memorize the interrupt position, regardless of whether the [RESUME] mode is set to [ON] or [DISC RESUME].

# Variable speed playback

You can speed up or slow down playback, or advance the video frame by frame.

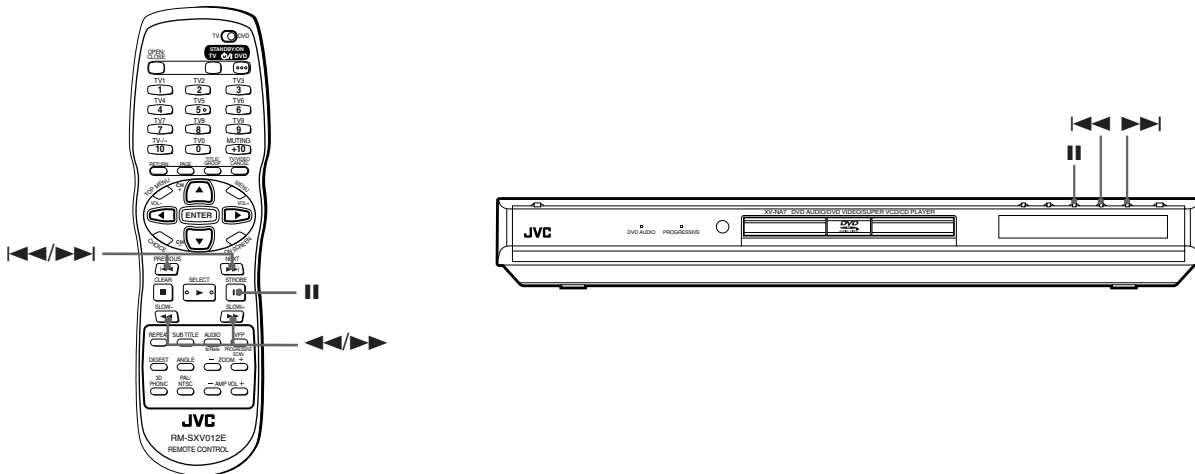

Basic operations

## To advance or reverse playback rapidly while monitoring

Available : **DVD AUDIO** **DVD VIDEO** **Super VCD** **Video CD** **Audio CD**

- During playback

### Method 1 (from the remote control unit only)

Press ◀◀ or ▶▶.

Each press of ◀◀ or ▶▶ decreases or increases the playback speed. You can select from 2 times, 5 times, 10 times, 20 times and 60 times normal speed.

Pressing ▶ returns the unit to normal playback.

### Method 2

Hold down ◀◀◀ or ▶▶▶.

Holding down ▶▶▶ advances playback rapidly, while holding down ◀◀◀ reverses playback rapidly, at 5 times the normal speed. Releasing the button returns the unit to normal playback.

#### NOTES

- During rapid playback, the sound will be muted except when playing an Audio CD. When using rapid playback with an Audio CD, the sound will be played discontinuously.
- This function does not work for an MP3 disc.

## To advance a still picture frame by frame

Available : **DVD VIDEO** **Super VCD** **Video CD**

- While paused (still)

Press ⏸.

Each time you press ⏸, the still picture advances to the next frame.

Pressing ▶ returns to normal playback.



## To playback in slow-motion

Available :   

You can playback video in slow-motion. You can select from 1/32 times, 1/16 times, 1/8 times, 1/4 times and 1/2 times normal speed.

- During playback

Press **II**, then use **◀◀/▶▶**.

To play forward slow motion, press **▶▶**, and to play reverse slow motion (for DVD VIDEO discs only), press **◀◀**. First, the unit plays the slowest speed, and each time you press the button, the playback speed increases. Pressing **▶** returns to normal playback. Pressing **II** pauses slow motion playback.

### NOTES

- The sound is muted during slow motion playback.
- Reverse slow motion playback is not possible for a SVCD and Video CD.

## To locate the beginning of the scene or song

You can locate the desired group or track (for DVD AUDIO), title or chapter (for DVD VIDEO), or track (for SVCD/Video CD/Audio CD) from which the unit starts playback.

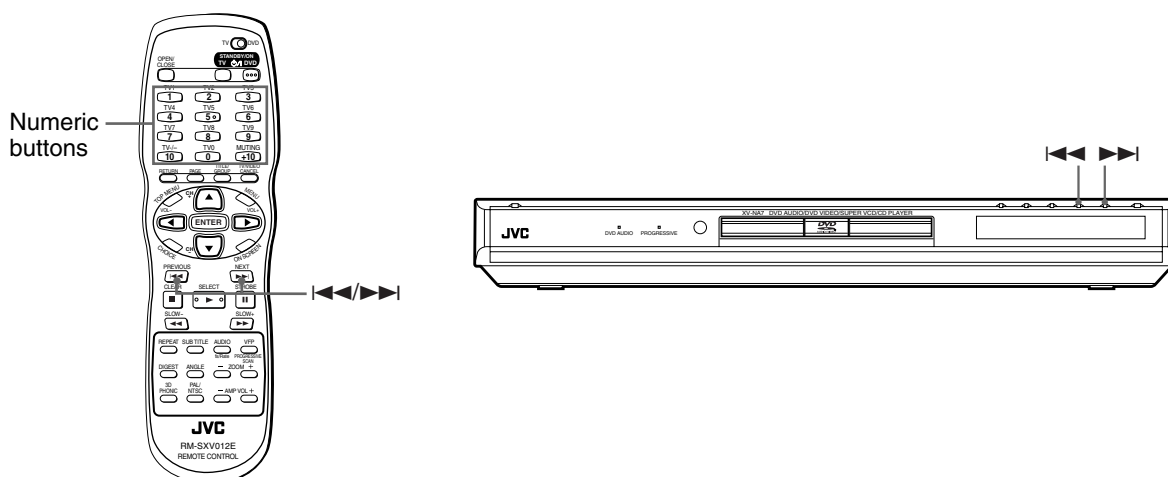

## To locate a desired selection using **◀◀** or **▶▶**

Available :     

- For DVD AUDIO/Audio CD: During playback or while stopped
- For DVD VIDEO: During playback
- For SVCD/Video CD: During playback without PBC function

Press **◀◀** or **▶▶**.

With a DVD AUDIO, pressing the button skips a group or track depending on the disc configuration. With a DVD VIDEO disc, pressing the button skips a chapter or title depending on the disc configuration.

With an SVCD, Video CD or Audio CD, pressing the button skips a track.

The selection number appears in the display window on the front panel.

- To skip forward titles/chapters/groups/tracks, press **▶▶** as many times as required.
- To skip to the beginning of the current titles/chapters/groups/tracks, press **◀◀** once.
- To skip back titles/chapters/groups/tracks, press **◀◀** as many times as required.

### NOTES

- This function may not work with some DVD VIDEO discs.
- This function does not work during SVCD/Video CD playback with PBC function (see pages 5 and 27).

## To locate a desired selection using the numeric buttons

Available :     

- For DVD AUDIO/DVD VIDEO/Audio CD: During playback or while stopped  
 For SVCD/Video CD: During playback without PBC function or while stopped

Use the numeric buttons to specify the number.

Depending on the disc type and the unit status, what is specified differs.

Unit status	Disc type	What is specified
While stopped	DVD AUDIO	group or track* <sup>1</sup>
	DVD VIDEO	title or chapter* <sup>2</sup>
	SVCD/Video CD/Audio CD	track
During playback	DVD AUDIO	track
	DVD VIDEO	chapter
	SVCD/Video CD/Audio CD	track

\*<sup>1</sup>Pressing the numeric buttons simply selects a track. To select a group (when a disc contains more than one group), press TITLE/GROUP before press the numeric buttons.

\*<sup>2</sup>Pressing the numeric buttons simply selects a chapter when a disc contains only one title, or selects a title when a disc contains more than one title.

The selected title, group or track number appears in the display window on the front panel.

- To select a number between 1 and 10: Press the corresponding button for the number.
- To select a number higher than 10: Use the +10 button.

Examples:

To select 13: +10 → 3

To select 34: +10 → +10 → +10 → 4

To select 40: +10 → +10 → +10 → 10

The unit starts playback from the beginning of the selection. The selected title, chapter, group or track number appears in the display window on the front panel.

### NOTES

- You can also specify the desired title during DVD VIDEO playback. See page 28 for details.
- During DVD AUDIO/DVD VIDEO playback, if a menu is shown on the TV screen, the numeric buttons may be used for selecting an item in the menu.
- When  appears on the TV screen:  
 The title, chapter group or track you have selected is not contained in the disc.
- This function does not work during SVCD/Video CD playback with PBC function (see pages 5 and 27).

## Other convenient functions

You can check the playback status, as well as change the brightness of the display window. Also, you can move back the playback position 10 seconds from the current position.

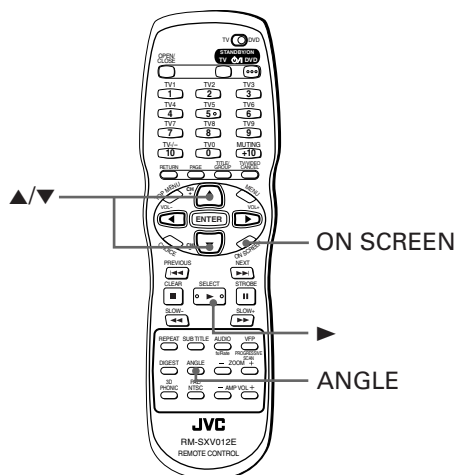

## To check the playback status

Available : **DVD AUDIO** **DVD VIDEO** **Super VCD** **Video CD** **Audio CD**

You can see the current selection number (the group/track number for DVD AUDIO, the title/chapter number for DVD VIDEO or track number for SVCD/Video CD/Audio CD), time information (the track, group or chapter time while stopped, or the elapsed track, group or chapter time during playback) and the transport status (stop, playback, pause etc.) on the TV screen.

- During playback or while stopped

Press ON SCREEN.

The playback status bar appears on the TV screen.

(for DVD AUDIO)

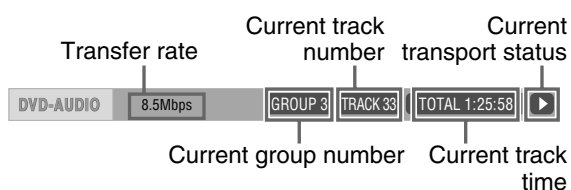

(for SVCD)

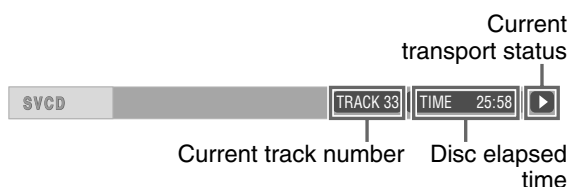

(for Audio CD)

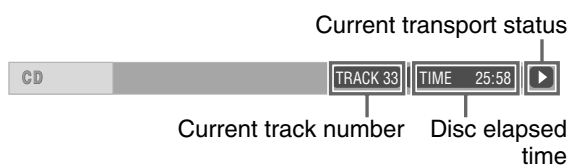

(for DVD VIDEO)

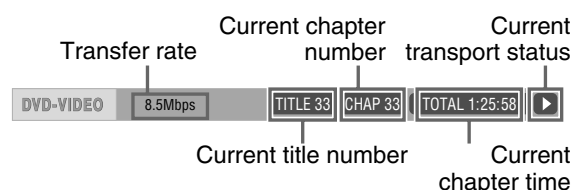

(for Video CD)

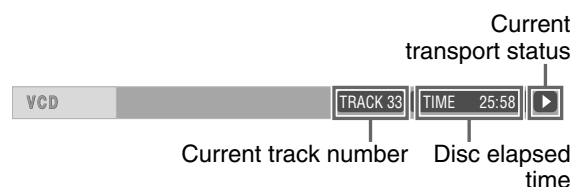

The indication on the rightmost end of the status bar shows the unit's transport status as follows:

Icon	Status
	Playback mode.
	Stop mode.
	Pause mode.
	Fast forward/backward playback mode.
	Slow motion playback mode.

Note that pressing ON SCREEN again brings up the menu bar under the status bar, from which you can access various functions.

(Example of the menu bar for DVD VIDEO)



See page 43 for details about the menu bar.

**NOTES**

- **To dismiss the status bar:**  
Press ON SCREEN until the status bar is dismissed.
- **The status bar cannot be displayed during MP3/JPEG playback.**

## To move back the playback position during DVD VIDEO playback [One touch replay function]

Available :

During playback of a DVD VIDEO disc, you can move back the playback position 10 seconds from the current position.

- During DVD VIDEO playback

Press .

The playback position moves back 10 seconds before the current position.

Note that this function works only within the same title, though it works between chapters.

If you press within 10 seconds from the beginning of a title, playback starts from the beginning of the title.

**NOTES**

- **This function works only with DVD VIDEO discs.**
- **When appears on the TV screen:**  
This function may not work with some DVD VIDEO discs.

## To change the brightness of the display window

You can adjust the brightness of the display window.

Press or while holding down ANGLE.

You can select the display window brightness from four levels, or off. If the brightness is set to off, nothing will be shown on the display.

# Advanced operations

This chapter describes operations for various advanced functions of DVD AUDIO, DVD VIDEO, SVCD, Video CD and Audio CD discs. For MP3 and JPEG disc playback, see the separate chapters beginning on pages 47 and 51.

## NOTE



Make sure that the TV - DVD switch on the remote control unit is set to "DVD" when using the ▲/▼/◀/▶, numeric and TV/VIDEO - CANCEL buttons for controlling the unit.

## Playing from a specific position on a disc

You can play a disc from the selected track, title or chapter, or from the specified time.

## To locate a desired scene from the DVD menu

Available : **DVD AUDIO** **DVD VIDEO**

DVD AUDIO/DVD VIDEO discs generally have their own menus which show the disc contents. These menus contain various items such as titles of movies, names of songs, or artist information, and display them on the TV screen. You can locate a desired scene using the DVD menu.

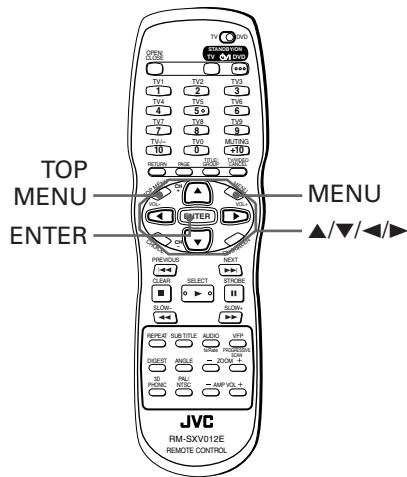

- Whenever a DVD AUDIO/DVD VIDEO disc is loaded

- Press TOP MENU or MENU.  
The menu appears on the TV screen.  
Example

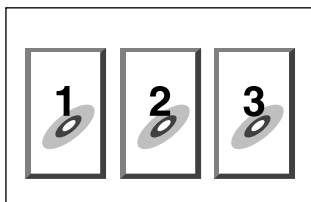

### About DVD menu

Normally, a DVD AUDIO disc which contains more than one group may have a "top" menu which lists the groups. Similarly, a DVD VIDEO disc which contains more than one title may have a "title" menu which lists the titles. In this case, the menu appears on the TV screen when you press the TOP MENU button. Some DVD AUDIO/DVD VIDEO discs may also have a different menu which appears when the MENU button is pressed.

See the instructions of each DVD AUDIO/DVD VIDEO disc for its particular menu.

- Use ▲/▼/◀/▶ to select a desired item, then press ENTER.

The unit starts playback of the selected item.



- With some discs, you can also select items by entering the corresponding number using the numeric buttons, which may cause the unit to automatically start playback

## NOTES

- When appears on the TV screen when you press TOP MENU or MENU in step 1:  
The disc does not have an appropriate menu listing the titles.
- The MENU button does not work while stopped.

## To locate a desired scene from the menu of a SVCD/Video CD with PBC

Available : **Super VCD** **Video CD**

Some SVCD/Video CD discs support the PBC function. PBC is an abbreviation of "PlayBack Control." A SVCD/Video CD disc recorded with PBC has its own menu, such as a list of the songs of the disc. You can locate a specific scene by using the PBC menu.

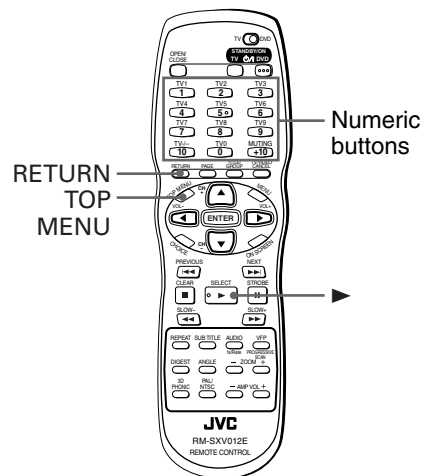

- When a SVCD/Video CD disc with PBC is stopped

**1** Press ► or TOP MENU.

A disc menu appears on the TV screen (the PBC function is activated).

Example

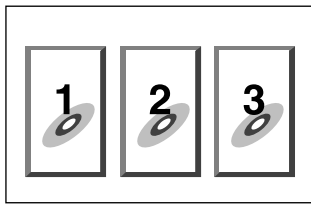

[PBC] is indicated in the display window on the front panel.

**2** Use the numeric buttons to select the desired item.

- To select a number between 1 and 10: Press the corresponding button for the number.
- To select a number higher than 10: Use the +10 button.

Examples:

- To select 13: +10 → 3
- To select 34: +10 → +10 → +10 → 4
- To select 40: +10 → +10 → +10 → 10

The unit starts playback of the selected item. You can return to the menu by pressing the RETURN button.

When something like [NEXT] or [PREVIOUS] appears on the TV screen, the unit generally works as follows:

- Pressing ► advances to the next page.
- Pressing ◀ returns to the previous page.
- \* The method of the operation may be different on different discs.

**Hints**

- If you want to play a PBC-compatible SVCD/Video CD disc without activating the PBC function, start playback using the numeric buttons instead of ►. (See page 24).
- To activate the PBC function when a PBC-compatible SVCD/Video CD disc is being played back without the PBC function, do any of the following:
  - \* Press TOP MENU or MENU.
  - \* Press ■ to stop playback, then press ►.

**To specify a desired title/group**



Available :

While playing back a DVD AUDIO/DVD VIDEO disc with more than one title or one group, you can specify a desired title to or group to be played using the numeric buttons.

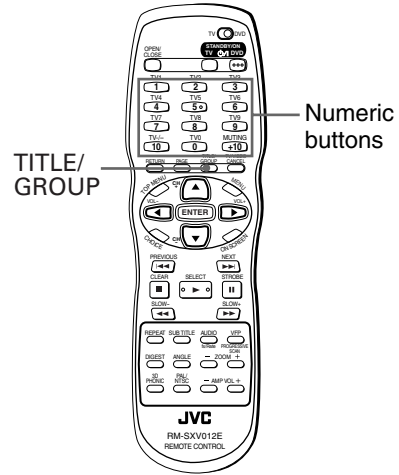

- During playback

**1** Press TITLE/GROUP.

[--] is shown in the title display area of the display window.

(Display window example for DVD VIDEO)

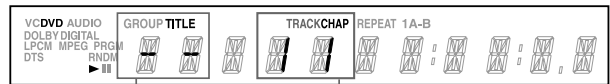

Title display area      Current chapter number

**2** Use the numeric buttons to specify a title or group to be played.

- To select a number between 1 and 10: Press the corresponding button for the number.
- To select a number higher than 10: Use the +10 button.

Examples:

- To select 13: +10 → 3
- To select 34: +10 → +10 → +10 → 4
- To select 40: +10 → +10 → +10 → 10

The unit starts playback from the specified title or group.

**NOTE**

- This function may not work with some DVD AUDIO/ DVD VIDEO discs.

## To locate a desired position in the current title, group or track [Time search]

Available : **DVD AUDIO** **DVD VIDEO** **Super VCD** **Video CD** **Audio CD**

You can play a disc from the desired position by specifying the time from the beginning of the current group (for DVD AUDIO), current title (for DVD VIDEO), or the disc (for SVCD/Video CD/Audio CD) using the time search function.

Note that some DVD VIDEO discs do not contain time information, and the time search function cannot be used.

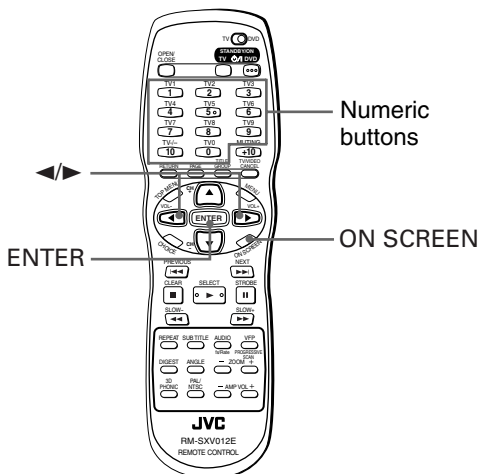

- For DVD AUDIO/DVD VIDEO/Audio CD:  
During playback or while stopped
- For SVCD/Video CD:  
In any condition except SVCD/Video CD playback with PBC

### 1 Press ON SCREEN twice.

The menu bar appears on the TV screen.  
(See page 43 for details about menu bar.)

### 2 Use ◀▶ to move to , then press ENTER.

The pull-down menu for entering time appears under the .

(Screen example for DVD VIDEO)

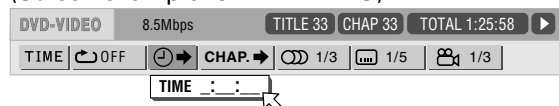

(Screen example for Audio CD)

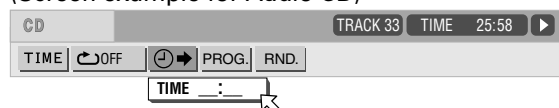

### 3 Use the numeric buttons (0 to 10) to enter the desired time.

The specified time is displayed in the pull-down menu.

### Hints

- "10" button works as "0" and "+10" button is not used with this function.
- You can specify the time in hour/minute/second format for DVD AUDIO/DVD VIDEO discs, and in minute/second format for SVCD and Video CD/Audio CD discs.

### 4 Press ENTER.

The unit starts playback from the specified time.

#### ● Example (for DVD AUDIO/DVD VIDEO)

To playback from 2(H):34(M):00(S)

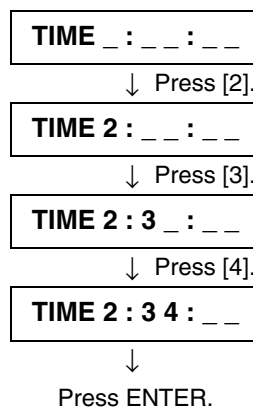

#### ● Example (for SVCD/Video CD/Audio CD)

To playback from 23(M):40(S)

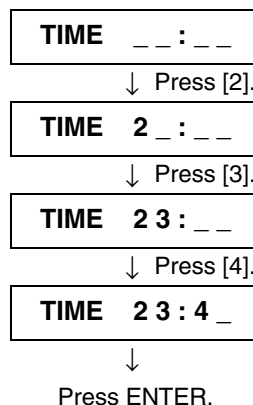

You do not have to press "0" to enter the trailing zeros (for the last two digits in the example above).

#### ● To correct a mistake

Use ◀ repeatedly to move back to the digit where you entered a undesired numeral (the leftmost [-] digit), and reenter the correct time.

(Example : changing [2:35:\_] to [2:34:\_].)

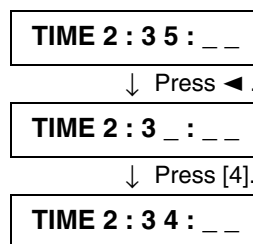

**NOTES**

- When a DVD AUDIO disc is stopped, you can specify the elapsed time from the beginning of group 1.
- When  appears on the TV screen:  
The time you have selected is not contained on the disc, or the time search function does not work on the disc. Also note that the time search function does not work during SVCD/Video CD playback with the PBC function.
- To dismiss the menu bar:  
Press ON SCREEN.
- The time search function cannot be used during program playback.

**To locate a specific scene from the display [DIGEST]**

Available :   

The unit can display the opening scene of each title or chapter on a DVD VIDEO or each track of a SVCD/Video CD. You can select a specific scene from those displayed on the TV screen.

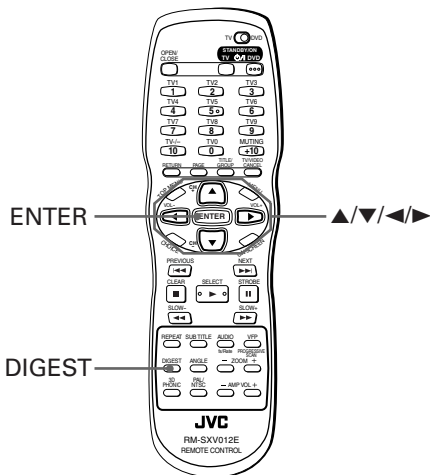

- For DVD VIDEO: During playback or while stopped
- For SVCD/Video CD: In any condition except SVCD/Video CD playback with PBC



**1 Press DIGEST.**



Up to nine opening scenes are displayed.



Depending on the disc type and whether the disc is being played back or not, the contents shown on the TV screen differ.

Disc type	Unit status	What is displayed
DVD VIDEO	While stopped	The opening scene of each title
	During playback	The opening scene of each chapter in the current title
SVCD/Video CD	While stopped or during playback	The opening scene of each track





**2 Use  to move  to select the desired scene.**

If there are more than 9 scenes, the digest screen will have more than one page. In this case, pressing  advances to the next page, while pressing  returns to the previous page.



Selected scene

**Hints**

- When the lower right scene is selected, pressing  advances to the next page if available. Similarly, when the upper left scene is selected, pressing  returns to the previous page (if available).
- Depending on discs, it may take some time until all scenes of the current page appear on the TV screen. If you want to turn the page, you do not have to wait to press  or  until all scenes appear.

**3 Press ENTER.**

The unit starts playback from the selected scene.

**NOTE**

- With some discs, depending on the contents, it may take some time until all the scenes appear on the screen.



## To select a still picture on a DVD AUDIO disc [PAGE]

Available : 

Most DVD AUDIO discs include still pictures, which usually appear in turn automatically during playback according to the playback sequence. However, there are other page(s) of the current still picture and you can change the picture (turn the page) manually.



- At the beginning of a part where there are selectable pictures, [PAGE] appears on the TV screen (except when the [ON SCREEN GUIDE] preference is set to [OFF]). See page 62 for details about [ON SCREEN GUIDE] preferences.

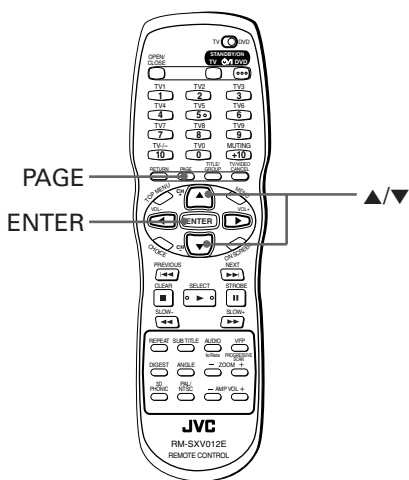

- During playback (except when the status bar is shown)

### 1 Press PAGE.

The Page selection window appears on the TV screen.

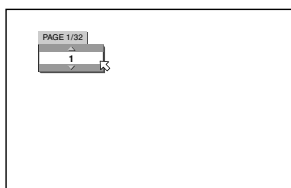

### 2 Use PAGE or ▲/▼ to select the desired page.

Each time you press PAGE or ▲/▼, the page number changes.

### 3 Press ENTER.

The selected page (picture) is shown. The Page selection window is dismissed.

#### NOTES

- The Page selection window will automatically disappear if you do not change the page for several seconds.
- You can also select the page via the menu bar. See page 44.

## To play back a bonus group of a DVD AUDIO disc

Available : 

Some DVD AUDIO discs contain a special group called "bonus group" whose contents are not opened to the public. The bonus group is always assigned to the last group of a disc (for example, if a disc contains four groups including a bonus group, "group 4" is the bonus group).

To play back a bonus group, you have to enter the specific "key number" (a kind of password) for the bonus group. A way of getting the key number depends on discs.

After getting the key number, you can play back the bonus group by the following procedure.

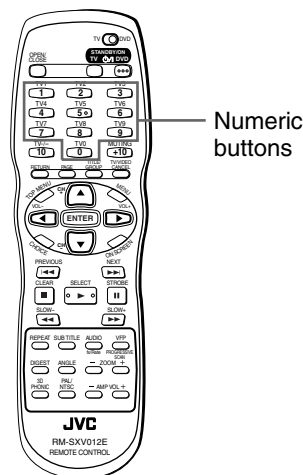

- While a disc containing a bonus group is stopped

### 1 Use the numeric buttons to select the bonus group number (the last group).

The display window and on-screen display prompt you to enter the key number as shown below.

(Display Window)



(TV screen)

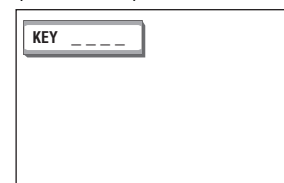

### 2 Use the numeric buttons (0 to 9) to enter the key number.

If you enter the key number correctly, the unit starts playback of the bonus group. If you enter a wrong key number, the unit does not start playback and the display window and TV screen again prompt you to reenter the key number.

**NOTES**

- Once you enter the correct key number, the unit memorizes it until you turn off the power or open the disc tray.
- If you specify a track in the bonus group when programming tracks for the program playback, the display window will also show the above display for inquiring the key number.
- In the random playback mode, tracks in the bonus group are not played back.
- To turn off the key number entry display, operate any one of the following.
  - \* Press ■ .
  - \* Open the disc tray.
  - \* Turn the power off.
 Opening the disc tray or turning the power off also erases the memory of the key number, while pressing ■ does not erase the memory.

# Changing the playback order

You can play tracks on a DVD AUDIO, SVCD, Video CD or Audio CD in a specific order or in random order.

## To playback in a specific order [Program play]

Available : **DVD AUDIO** **Super VCD** **Video CD** **Audio CD**

By programming tracks, you can play up to 99 tracks in any order. You may program the same track more than once.

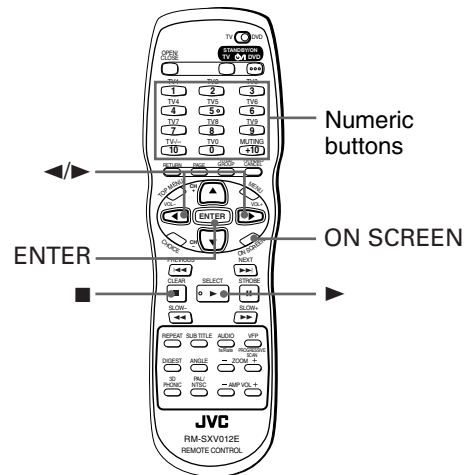

● While stopped

- 1 Press ON SCREEN twice.  
The menu bar appears on the TV screen. (See page 43 for details about menu bar.)
- 2 Use ◀▶ to move to **PROG.**.  
(Screen example for DVD Audio)



- 3 Press ENTER.  
The program table appears instead of the menu bar. The PROGRAM indicator lights in the display window on the front panel.

(Program table example for DVD AUDIO)

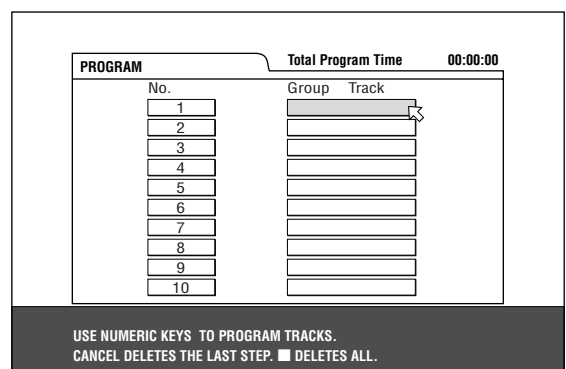

**4 a** (for DVD AUDIO)

Specify selections in the desired order by group and track numbers using the numeric buttons.

- For each program step, using the numeric buttons, specify a group first, then specify a track.
- For example, to specify "track 14 in group 2," Press 2 → +10 → 4.

**4 b** (for SVCD/Video CD/Audio CD)

Specify tracks in the desired order using the numeric buttons.

- To select a number between 1 and 10:  
Press the corresponding button for the number.
- To select a number higher than 10:  
Use the +10 button.

Examples:

To select 13: +10 → 3  
 To select 34: +10 → +10 → +10 → 4  
 To select 40: +10 → +10 → +10 → 10

Up to 99 tracks can be programmed. You may select the same track more than once. The total program time is shown at the right top of the program table.

(Program table example for DVD AUDIO)

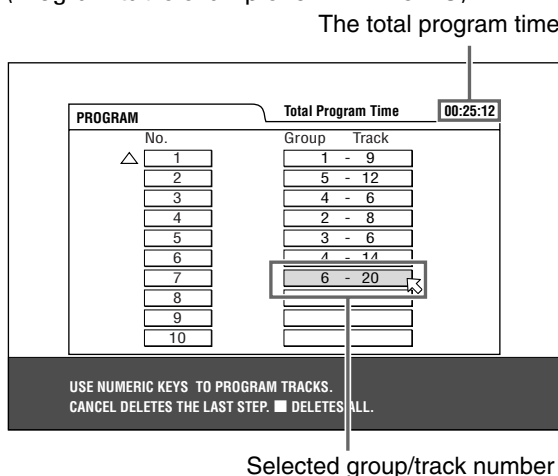
**• If you specify a wrong track**

Use ▲/▼ to move  $\leftarrow$  to the wrong track, then press TV/VIDEO - CANCEL. The track is erased and the subsequent programmed tracks move up.

**• To clear the program while programming**

Press ■.

**5** Press ► to start program playback.

With a DVD AUDIO/SVCD/Video CD disc, the program table is automatically dismissed when the program playback starts.

With an Audio CD disc, the program table remains on the TV screen during program playback. However, pressing the ON SCREEN button brings up the status bar.

When all of the programmed tracks have finished playback, the unit stops and the program table appears again.

Note that the program remains.

**• To check the program contents**

During playback, press ■. Playback stops and the program table is shown.

When the unit is playing back an Audio CD and the program table is not shown, you can bring up the table by carrying out steps 1 to 3.

During DVD AUDIO/SVCD/Video CD playback, you cannot see the program table during playback.

**• To quit program playback**

Press ■. Note that the program remains.

**• To clear the program**

While stopped and the program table is shown on the TV screen, press ■.

All the programmed tracks are erased.

**• To exit the program mode**

After clearing all programmed tracks, press ON SCREEN.

The program table is dismissed and the status bar appears on the TV screen.

The PROGRAM indicator in the display window disappears and the unit quits program playback mode.

**NOTES**

- **During program playback, you cannot edit the program contents.**
- **During program playback, pressing ►| skips to the next selection of the program. Pressing |◀ returns to the beginning of the current selection.**
- **If you are going to program a track in the bonus group of a DVD AUDIO, the unit will ask you to enter the key number for the bonus group (see page 31).**
- **To dismiss the program table:**  
Press ON SCREEN. The program table is dismissed and the status bar is shown.
- **To dismiss the menu bar (and the status bar):**  
Press ON SCREEN.

## To playback in random order [Random play]

Available : **DVD AUDIO** **Super VCD** **Video CD** **Audio CD**

You can play tracks on a disc in random order by using the random function.

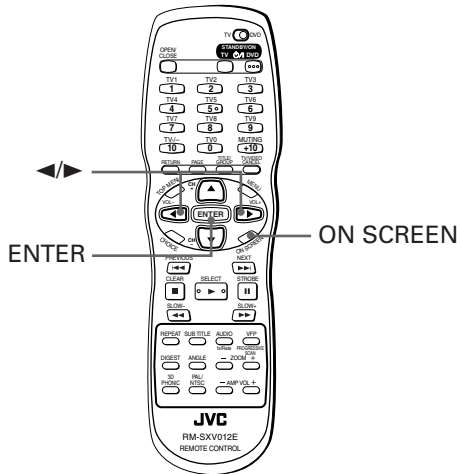

● While stopped

**1** Press ON SCREEN twice.

The menu bar appears on the TV screen. (See page 43 for details about menu bar.)

**2** Use ◀/▶ to move to **RND.**

(Screen example for Audio CD)

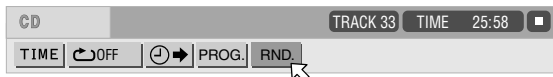

**3** Press ENTER.

The unit starts random playback. With a DVD AUDIO/SVCD/Video CD disc, the menu bar is automatically dismissed. During random playback, the RANDOM indicator lights in the display window on the front panel. After playing all tracks of the disc, the unit stops the disc and exits the random mode.

**Hints**

- The same track will not be played back more than once during random play.
  - During random playback, if you bring up the menu bar and carry out steps 1 to 3 above, the unit cancels random playback mode and continues playback from the current selection in the recorded order.
  - In the random playback mode with the DVD AUDIO, tracks in the bonus group are not played back (see page 31).
- **To stop and quit random playback**  
Press . The unit stops playback and exits the random playback mode.

**NOTE**

- **To dismiss the menu bar:**  
Press ON SCREEN.

## Repeat playback

You can repeat playback of the current group or track (for DVD AUDIO), current title or chapter (for DVD VIDEO), or current track or all tracks (for SVCD/Video CD/Audio CD).

You can also repeat playback of a desired part.

## To repeat the current selection or all tracks [Repeat playback]

Available : **DVD AUDIO** **DVD VIDEO** **Super VCD** **Video CD** **Audio CD**

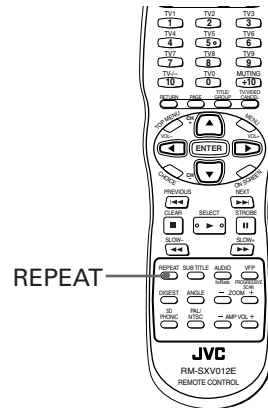

● For DVD AUDIO/DVD VIDEO:

During playback

For SVCD/Video CD/Audio CD:

In any condition except SVCD/Video CD playback with PBC

**1** Press REPEAT.

Each time you press REPEAT, the repeat mode cycles among All repeat, Repeat 1 and off. The selected mode is reflected in icons displayed in the front panel display window, as shown below.

If you press REPEAT while stopped, you need to press ▶ to start repeat playback.

**REPEAT:** Repeats the current group for DVD AUDIO, current title for DVD VIDEO or all tracks for SVCD/Video CD/Audio CD.

**REPEAT 1:** Repeats the current chapter for DVD VIDEO or the current track for DVD AUDIO/SVCD/Video CD/Audio CD.

**No indication:** The repeat mode is off.

(Display window)



Repeat mode indicators

A window which indicates the current repeat mode will be displayed on the TV screen.

The mode indication on the window is same as the one on the menu bar (see pages 44, 45 and 46).

(Repeat mode example on the TV screen)



**To stop repeat playback**

Press **■**.

When a DVD VIDEO or DVD AUDIO disc is set, the unit stops playback and quits the repeat mode.

When an SVCD, Video CD or Audio CD disc is set, the unit stops playback but does not quit the repeat mode.

**To quit repeat playback**

Press REPEAT until the repeat mode indicator goes off in the display window.

**NOTES**

- You can also select the repeat mode via the menu bar. See pages 44, 45 and 46.
- When the program playback mode is active with a DVD AUDIO, SVCD, Video CD or Audio CD, the repeat mode changes in the same manner. Note that, however, in the "⏮" mode the unit repeats all the programmed tracks, instead of all tracks on the disc.
- During playback in the title/chapter/group/track repeat mode, if you skip the title/chapter/group/track using **⏮**/**⏭**, etc., the destination title/chapter/group/track is repeated.
- If **⏮** appears when pressing REPEAT during DVD VIDEO playback. The disc content does not allow title or chapter repeat.
- Repeat playback function cannot be used during SVCD/Video CD playback with PBC function.

**To repeat a desired part [A-B repeat playback]**

Available : **DVD AUDIO** **DVD VIDEO** **Super VCD** **Video CD** **Audio CD**

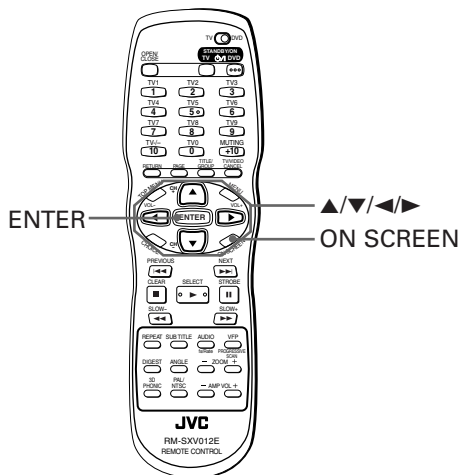

- During playback except SVCD/Video CD playback with PBC

**1 Press ON SCREEN twice.**

The menu bar appears on the TV screen. (See page 43 for details about menu bar.)

**2 Use **⏮**/**⏭** to move **⏮** to **⏮**, then press ENTER.**

The pull-down menu for repeat mode selection appears under the **⏮**.

**3 Use **▲**/**▼** to select [A-B].**

Depending on the disc type and unit's status the repeat mode changes as follows:

**• During DVD AUDIO playback**

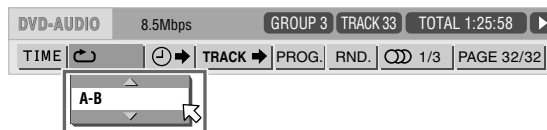

Selected repeat mode

- TRACK :** current track repeat
- GROUP :** current group repeat
- A-B :** repeats a desired part (during playback only)
- OFF**

**• During DVD VIDEO playback**

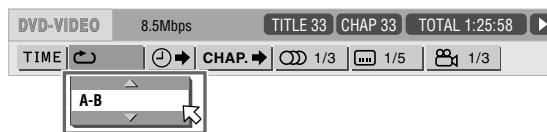

Selected repeat mode

- CHAPTER :** current chapter repeat
- TITLE :** current title repeat
- A-B :** repeats a desired part (during playback only)
- OFF**

**• SVCD/Video CD/Audio CD**

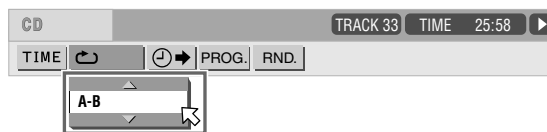

Selected repeat mode

- TRACK :** current track repeat
- ALL :** all track repeat
- A-B :** repeats a desired part (during playback only)
- OFF**

Advanced operations

- Press ENTER at the beginning of the part you want to repeat (point A).  
The pull-down menu disappears.  
The repeat icon shows .  
(Screen example for DVD VIDEO)





Repeat icon

- Press ENTER at the end of the part you want to repeat (point B).  
The repeat icon show .  
The unit locates [A] and starts repeat playback between [A] and [B].

- To quit A-B repeat playback**  
Press ENTER. The A-B repeat mode turns off, while the playback continues.

 Hints

- Selecting [OFF] from the pull-down menu for repeat mode selection, or pressing  quits the A-B repeat mode and continues playback.
- You can also stop and quit A-B repeat mode by pressing .

**NOTES**

- The A and B points must be set in the same title/ chapter/group/track.**
- To dismiss the menu bar:**  
Press ON SCREEN.
- If  appears when pressing ENTER during DVD VIDEO playback**  
The disc content does not allow you to repeat the selected part.

Advanced operations

## Changing the language, sound and scene angle

With some DVD AUDIO/DVD VIDEO discs, you can choose a desired subtitle language and/or audio language/sound, as well as a desired camera angle. Some DVD AUDIO discs support more than one audio language/sound, with some DVD VIDEO discs support more than one subtitle language and/or audio language/sound.

Similarly, you can choose a desired audio channel (or channel combination) of a SVCD/Video CD disc, as well as a subtitle channel of an SVCD disc.

### To select the subtitle language [SUBTITLE]

Available :   

Some DVD AUDIO/DVD VIDEO and SVCD discs for movies, guides, etc. contain more than one subtitle language. You can choose a desired one from them.

 Hint

- At the beginning of the part where the subtitles are recorded,  appears on the TV screen (except when the [ON SCREEN GUIDE] preference is set to [OFF]). See page 62 for details about [ON SCREEN GUIDE] preference.

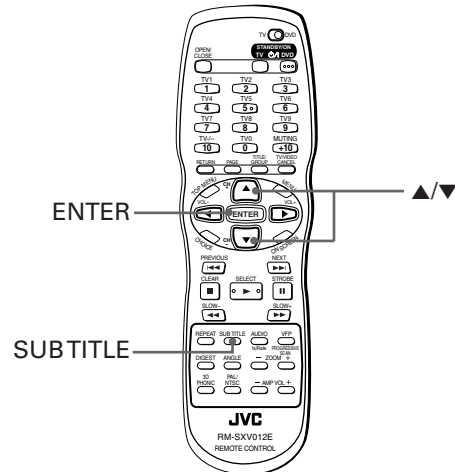

- During DVD AUDIO/DVD VIDEO/SVCD playback (except when the status bar is shown)

#### 1 Press SUBTITLE.

The Subtitle selection window appears on the TV screen.

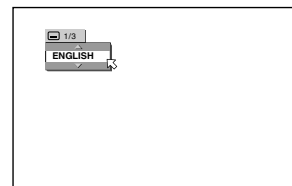

**2** Use ▲/▼ or SUBTITLE to select the subtitle. Each time you press ▲/▼ or SUBTITLE, the subtitle language changes. See the following examples for subtitle selection.

- **For DVD AUDIO/DVD VIDEO**  
Pressing ▲/▼ or SUBTITLE cycles through the subtitles recorded on the disc.

Example:

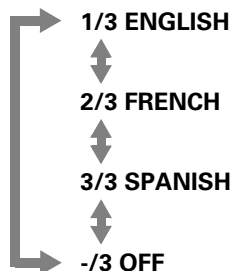

- **For SVCD**  
An SVCD disc can have up to four subtitles. Pressing ▲/▼ cycles through those channels as follows regardless of whether the subtitles are recorded or not.

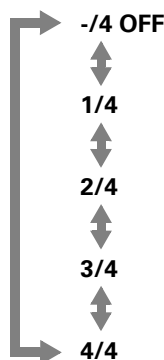

**3** Press ENTER. Subtitles are displayed in the selected language. The subtitle selection window is dismissed.

**NOTES**

- For DVD VIDEO, the selected language may be abbreviated on the TV screen. See "Table of languages and their abbreviations" on page 58.
- The Subtitle selection window will automatically disappear if you do not change the subtitle for several seconds.
- When a circle with a slash appears on the TV screen (for DVD AUDIO/DVD VIDEO disc): You cannot select the subtitle or no subtitle is recorded.
- You can also select the subtitle via the menu bar. See pages 45 and 46.

**To change the audio language or sound [AUDIO]**

Available : **DVD AUDIO** **DVD VIDEO** **Super VCD** **Video CD**

The audio selection setting allows you to change the audio language of a movie, or to listen to Karaoke with or without the vocal.



- At the beginning of the part where multiple audio tracks are recorded, a circle with a slash appears on the TV screen (except when the [ON SCREEN GUIDE] preference is set to [OFF]). See page 62 for details about [ON SCREEN GUIDE] preference.

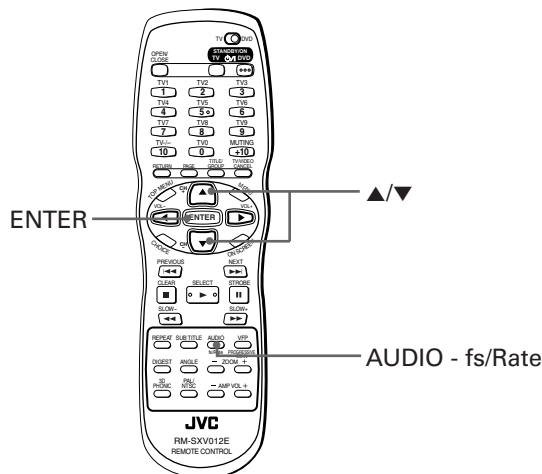

- During playback (except when the status bar is shown)

**1** Press AUDIO - fs/Rate.

The audio selection window appears on the TV screen.

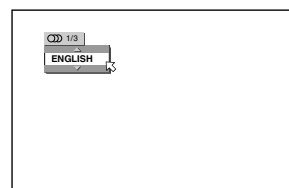

**2** Use AUDIO - fs/Rate or ▲/▼ to select the desired audio.

Each time you press ▲/▼ or AUDIO - fs/Rate, the audio changes. See the following examples for audio selection.

- **For DVD AUDIO/DVD VIDEO**  
Each time you press ▲/▼ or AUDIO - fs/Rate, the audio language or sound changes.

Example:

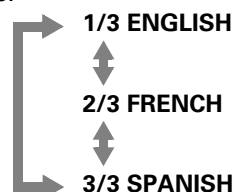

- **For SVCD/Video CD**  
Each time you press ▲/▼ or AUDIO - fs/Rate, the playback audio changes as follows.

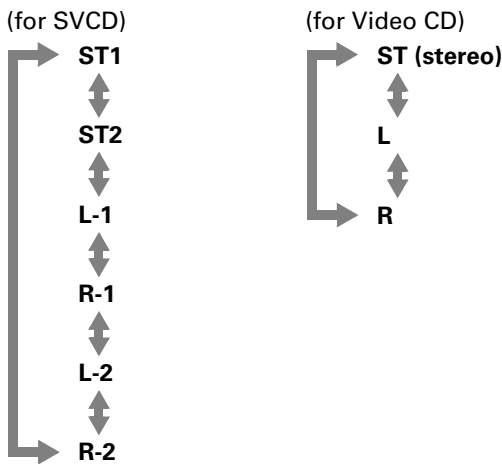

### 3 Press ENTER.

You can hear the selected audio.  
The audio selection window is dismissed.

#### NOTES

- For DVD VIDEO, the selected language may be abbreviated on the TV screen. See "Table of languages and their abbreviations" on page 58.
- The Audio selection window will automatically disappear if you do not change the audio for several seconds.
- When appears on the TV screen (for a DVD AUDIO/ DVD VIDEO disc):  
You cannot select the audio.
- If only one audio track is recorded, you cannot change the audio selection.
- You can also select the audio via the menu bar. See pages 44, 45 and 46.

## To select a scene angle of DVD VIDEO [ANGLE]

Available :

You can enjoy a variety of scene angles if the DVD VIDEO disc contains "multi-angle" parts, where multiple cameras were used to shoot the same scene from different angles.



- At the beginning of a "multi-angle" part, appears on the TV screen (except when the [ON SCREEN GUIDE] preference is set to [OFF]). See page 62 for details about [ON SCREEN GUIDE] preference.

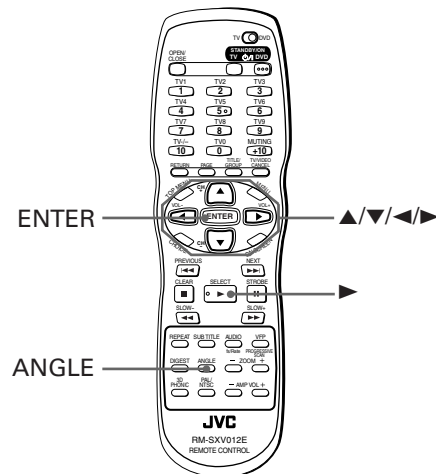

### From the Angle selection window

- During DVD VIDEO playback (except when the status bar is shown)

#### 1 Press ANGLE.

The Angle selection window appears on the TV screen.

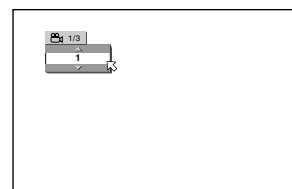

#### 2 Use ANGLE or ▲/▼ to select the desired angle.

Each time you press ANGLE or ▲/▼, the angle changes.

Example:

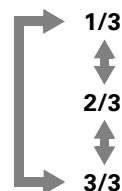

#### 3 Press ENTER.

You can see the picture from the selected angle.  
The angle selection window is dismissed.



## From the angle list

- During DVD VIDEO playback

- 1 Press and hold ANGLE for more than 1 second.

Up to nine camera angles recorded on a disc appear on the TV screen.

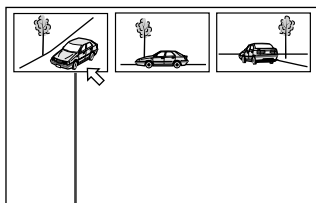

The selected camera angle

- 2 Use ▲/▼/◀/▶ to select the desired angle.

- 3 Press ENTER or ▶.

The unit starts playback using the selected angle on the full-sized screen.

### NOTES

- The Angle selection window will automatically disappear if you do not change the angle for several seconds.
- When ○ appears on the TV screen in step 1: The current scene is not recorded from multiple angles.
- During the operation from the angle list display, audio is muted.
- You can also select the angle via the menu bar. See page 45.

## Special picture playback and picture/sound effect

You can view continuous still images, or zoom into or out of the picture. You can also adjust the picture characteristics, as well as simulate surround sound using a stereo system.

### To display continuous still pictures [STROBE]

Available :

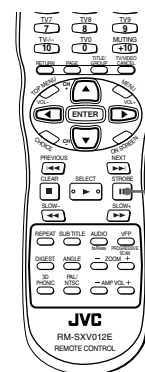

- During playback

- 1 At the point where you want to begin viewing continuous still images, press . The unit pauses playback.

- 2 Press and hold for more than 1 second. Nine copies of the same frame (still images) will appear on the TV screen. You can advance these frames using the following step.

- 3 Press once. The image in the middle of the top row shows the next frame of video after the one on the upper left.

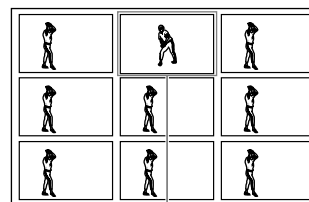

Advanced frame

Each press of advances the video by one frames. Pressing instead of advances each frame at normal playback speed with a time delay over the whole nine pictures (while the sound is muted).

- **To return to the normal screen**  
Press and hold for more than 1 second.

### NOTE

- If you press and hold for more than 1 second during playback, nine still pictures also appear but they advance at normal playback speed (while the sound is muted).

## To zoom in or out pictures [ZOOM]

Available : **DVD VIDEO** **Super VCD** **Video CD**

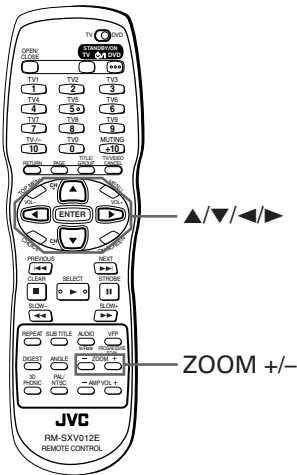

- During playback or while paused

### 1 Press ZOOM + or -.

Pressing ZOOM + causes the unit to zoom in on the image, and pressing ZOOM - causes the unit to zoom out.

Each time you press ZOOM +, the magnification is doubled (up to 1024 times). Each time you press ZOOM -, the magnification is halved (down to 1/8 times).

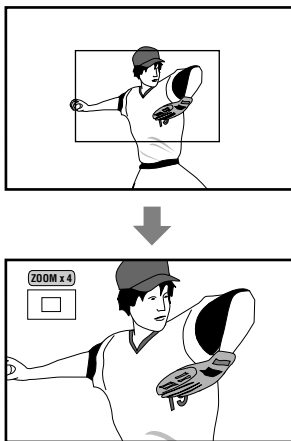

At the top left of the screen, the information for the current magnification appears for 5 seconds. While zoomed in, an indication of the zoomed image position also is displayed. The next step can be used to move the image position.

### 2 Use ▲/▼/◀/▶ to move the zoomed position.

If no button pressed for 5 seconds, the information for the current magnification disappears. To display the information, press ZOOM +/- or ▲/▼/◀/▶ again.

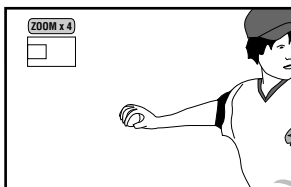

## NOTES

- To return to normal playback. Press ENTER.
- The zoom information on the screen will disappear if you do not operate the zoom function for 5 seconds.
- While zoomed, the picture may look coarse.

## To adjust the picture character [VFP]

Available : **DVD AUDIO** **DVD VIDEO** **Super VCD** **Video CD**

The VFP (Video Fine Processor) function allows you to adjust the picture character according to the type of programming, picture tone or personal preferences.

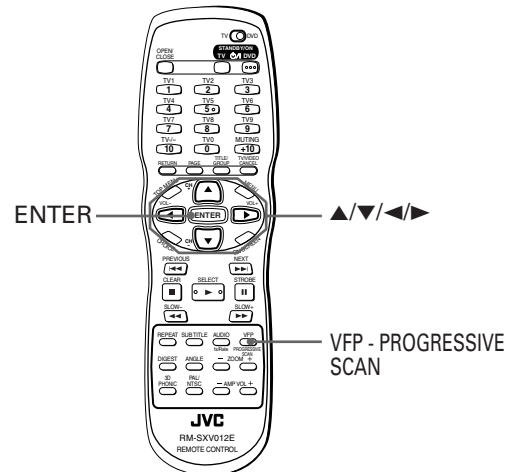

- During playback

### 1 Press VFP - PROGRESSIVE SCAN.

The VFP mode selection window appears on the TV screen.

### 2 Use ◀/▶ to select the desired preset.

Each time you press the button, the VFP mode changes as follows. Set the video type most suitable to the current program or the room conditions.

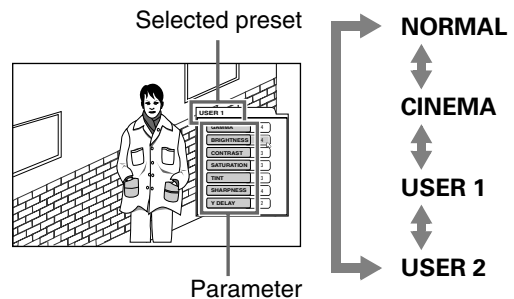

[NORMAL] is suitable for watching TV in a general room. [CINEMA] is suitable for watching a movie software in a room with suppressed light. They are factory presets and you cannot change parameters for them.

If you select [USER 1] or [USER 2], you can adjust parameters that affect the picture character and store the settings as a user preset. See the next step.

**3** To define a user setting, select a parameter to be edited using ▲/▼ from the following.

• **GAMMA**

Controls the brightness of a shaded portion without changing the brightness of the entire picture.

This control is optimum when you adjust the pictures of software which generates subdued black in a bright room.

The setting range is + 4 to - 4.

• **BRIGHTNESS**

Controls the brightness of the screen.

The setting range is +16 to - 16.

• **CONTRAST**

Controls the contrast of the screen.

The setting range is +16 to - 16.

• **SATURATION**

Controls the color depth of the screen.

The setting range is +16 to - 16.

• **TINT**

Controls the tint of the screen.

Use the appearance of a natural skin tone as a guideline.

The setting range is +16 to - 16.

• **SHARPNESS**

Controls the sharpness of the screen.

The setting range is + 3 to 0.

• **Y DELAY**

Controls the color gap of the screen.

The setting range is + 2 to - 2.

**4** Press ENTER.

A window for setting parameters appears instead of the VFP mode selection window.

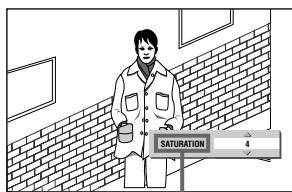

Selected parameter

**5** Adjust the level of the parameter using ▲/▼.

The higher value enhances the effect.

**6** Press ENTER.

The parameter is set and the VFP mode selection window appears again.

Repeat steps 3 to 6 if you want to set other parameters.

**NOTES**

- The number of setting steps varies for different parameters.
- To dismiss the VFP mode selection window: Press VFP - PROGRESSIVE SCAN.
- The window for VFP mode selection and parameter setting disappears if no operation is made for about 10 seconds.

## To simulate surround sound [3D PHONIC]

Available :

Using the 3D PHONIC function, you can get a simulated surround effect from your stereo system.

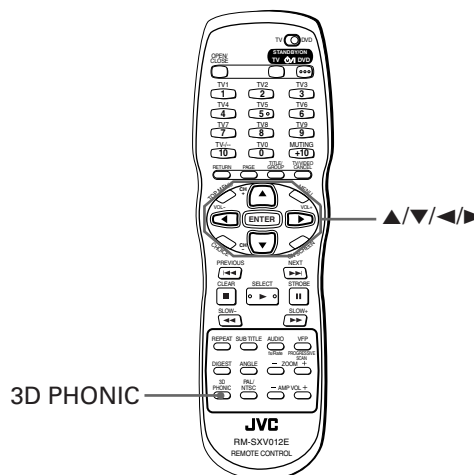

• During playback

**1** Press 3D PHONIC.

The 3D PHONIC window appears on the TV screen.

**2** Select the desired mode by using ◀/▶.

Each time you press the button, the 3D PHONIC mode changes as follows:

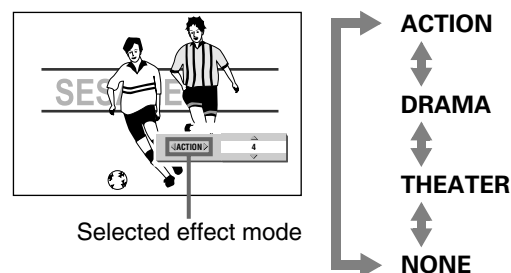

• **ACTION**

Suitable for action movies and sports programs in which the sound source moves.

• **DRAMA**

Natural and warm sound. You can enjoy movies in a relaxed mood.

• **THEATER**

You can enjoy sound effects like in a major theater in Hollywood.

- 3** Press ▲/▼ to adjust the effect level.  
 You can set the effect level from "1" to "5."  
 The higher value enhances the effect.

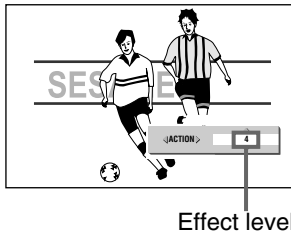

**NOTES**

- To dismiss the 3D PHONIC window: Press 3D PHONIC.
- The 3D PHONIC window disappears if no operation is made for about 10 seconds.
- The 3D PHONIC function works correctly only when playing back a DVD VIDEO disc recorded with Dolby Digital. Pressing the 3D PHONIC button will have no effect with other content.
- When playing back a DVD VIDEO disc recorded with Dolby Digital that does not contain the rear signal, you can change the 3D PHONIC setting, but you will not be able to achieve a correct 3D effect.
- The 3D PHONIC function does not affect the Dolby Digital bitstream signal from the DIGITAL OUT jack.
- When the 3D PHONIC function is active, the [ANALOG OUT] and [D. RANGE COMPRESSION] settings in the [AUDIO] setting display are disabled.

Advanced operations

## Checking the sampling frequency and bit rate

Available : DVD AUDIO DVD VIDEO Video CD Super VCD

You can check the sampling frequency and bit rate of digital audio during playback.

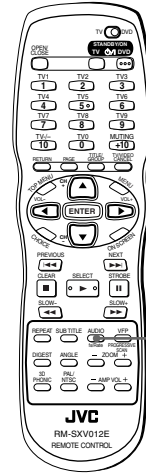

- During playback

- 1 Press and hold down AUDIO - fs/Rate for a few seconds.

The sampling frequency and bit rate of the current digital audio are shown in the display window temporarily. When the audio is recorded using a surround audio format, the sampling frequency and bit rate are shown for the front speakers.

(Example)

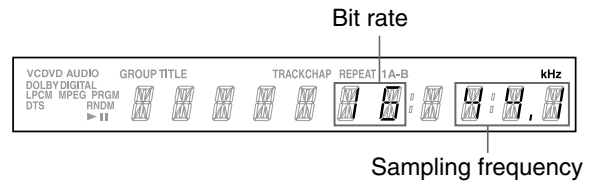

The sampling frequencies indicated are as follows: 44.1, 48, 88.2, 96, 176.4, and 192 (kHz). Note that any figure below the first decimal place is omitted in the display window.

**NOTE**

- With some discs, [NO INFO.] may appear instead of the sampling frequency and bit rate.

# Menu bar functions

This section describes the functions you can perform via the menu bar.  
The available menu bar functions differ depending on the disc type.

## To bring up the menu bar

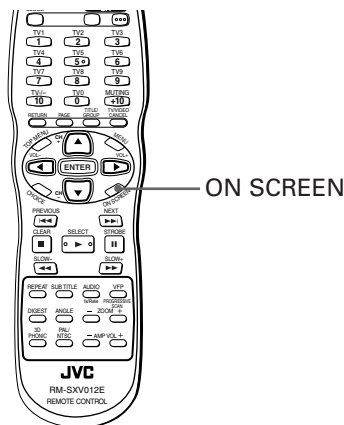

- When a disc is inserted

### 1 Press ON SCREEN.

A status bar for the type of disc loaded will appear on the TV screen.  
See page 25 about the status bar.

(Example of the status bar for DVD VIDEO)



### 2 Press ON SCREEN again.

A menu bar for the type of disc loaded will appear together with the status bar. The menu bar includes some icons which indicate their functions.

(for DVD AUDIO)



(for DVD VIDEO)



(for SVCD)

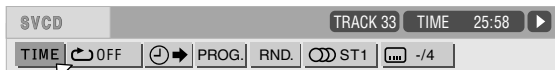

(for Video CD)

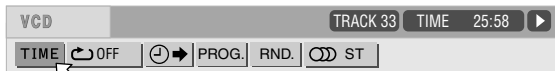

(for Audio CD)

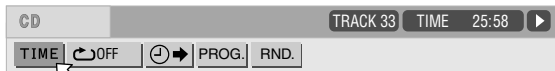

#### NOTE

- To dismiss the menu bar (and status bar):  
Press ON SCREEN.

## Basic operation procedure

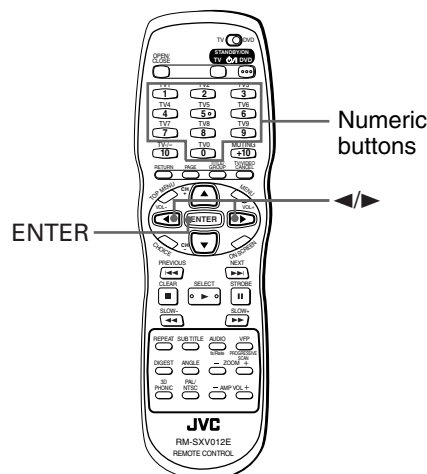

1 Use ◀▶ to select the icon you want to work with.  
The selected icon is pointed to by ↖.

2 Press ENTER.

With many icons, an appropriate pull-down window appears, however, there are some exceptions.

- See the following pages for details about each function.
- Note that some functions are not available during playback. (You cannot move ↖ to the associated icon when it is not available.)

#### NOTES

- When ⏻ appears on the TV screen:  
You cannot use the selected function because of disc contents.
- A mark or text on the menu icon for the function or mode currently selected is shown in blue.

Advanced operations

## Menu bar functions for DVD AUDIO

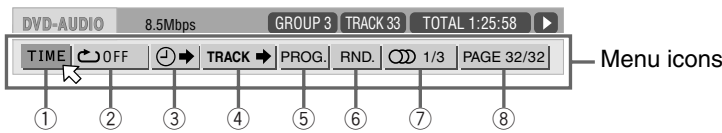

The following table shows the menu bar functions available for DVD AUDIO. Note that, in the description of the operation column, we assume the associated icon is selected.

Selected Icon	Operation	Note
<p>① <b>TIME</b></p> <p><b>Time mode selection</b> (During playback only) Selects the time mode shown in the display window on the front panel and in the status bar.</p>	<p>Press ENTER to select the time mode among the following.  <b>TIME → REM → TOTAL → T.REM → Return to initial</b></p> <ul style="list-style-type: none"> <li>• <b>TIME:</b> Current track elapsed time</li> <li>• <b>REM:</b> Current track remaining time</li> <li>• <b>TOTAL:</b> Current group elapsed time</li> <li>• <b>T.REM:</b> Current group remaining time</li> </ul>	<ul style="list-style-type: none"> <li>• If the disc has only one group and one track, [TOTAL] and [TIME] show the same value.</li> </ul>
<p>② <b>OFF</b></p> <p><b>Repeat mode</b> (During playback only) Select the repeat mode.</p>	<p>1 Press ENTER to open the pull-down window.                  2 Use ▲/▼ to select the repeat mode among the followings.  <b>TRACK ↔ GROUP ↔ A-B ↔ OFF</b></p> <ul style="list-style-type: none"> <li>• <b>TRACK:</b> Current track repeat</li> <li>• <b>GROUP:</b> Current group repeat</li> <li>• <b>A-B:</b> Repeats a desired part (A-B repeat)</li> </ul> <p>3 Press ENTER to make the selected repeat function active.                  (See pages 34 to 35 for details about repeat function.)</p>	<ul style="list-style-type: none"> <li>• If you select [OFF] during repeat playback, the unit continues playback without repeating.</li> <li>• For the subsequent operations for the A-B repeat, see page 35.</li> </ul>
<p>③ <b>TRACK</b></p> <p><b>Time search</b> Specifies the elapsed time from the beginning of the current group, from which the unit starts playback.</p>	<p>1 Press ENTER to open the pull-down window.                  2 Use numeric buttons to enter a desired time.                  3 Press ENTER to play back from the specified time.                  (See page 29 for details about time search function.)</p>	<hr/>
<p>④ <b>PROG.</b></p> <p><b>Track search</b> (During playback only) Specifies a desired track to be played back from.</p>	<p>1 Press ENTER to open the pull-down window.                  2 Use numeric buttons to enter a desired track number.  <ul style="list-style-type: none"> <li>• For example of entering "12," press "1" then "2."</li> </ul>                 3 Press ENTER to play back from the specified track.  <ul style="list-style-type: none"> <li>• <b>When the track number is incorrect:</b>                      Overwrite the incorrect number with the correct number.</li> </ul> </p>	<ul style="list-style-type: none"> <li>• The "10" and "+10" buttons are not used in this function.</li> <li>• You can also locate a desired track directly by specifying the track number using the numeric buttons during playback. See page 24.</li> </ul>
<p>⑤ <b>RND.</b></p> <p><b>Program</b> (While stopped only) Specifies the playback order of tracks.</p>	<p>1 Press ENTER to bring up the program table.                  2 Specify tracks in the desired order using the numeric buttons.                  3 Press ► to start program playback.                  (See page 32 for details about program playback.)</p>	<hr/>
<p>⑥ <b>1/3</b></p> <p><b>Random</b> (While stopped only) Activates random playback.</p>	<p>1 Press ENTER to activate random playback.                  (See page 34 for details about random playback.)</p>	<hr/>
<p>⑦ <b>PAGE 32/32</b></p> <p><b>Audio selection</b> (During playback only) Selects the audio language or sound.</p>	<p>1 Press ENTER to open the pull-down window.                  2 Use ▲/▼ to select a desired audio language or sound.  <b>Example:</b>  <b>1/3 ENGLISH ↔ 2/3 FRENCH ↔ 3/3 SPANISH</b></p> <p>3 Press ENTER to play back with the selected audio.                  (See page 37 for details about audio selection.)</p>	<hr/>
<p>⑧ <b>PAGE</b></p> <p><b>Page selection</b> (During playback only) Selects the page.</p>	<p>1 Press ENTER to open the pull-down window.                  2 Use ▲/▼ to select a desired page number.                  3 Press ENTER to play back with the selected page.                  (See page 31 for details about page selection.)</p>	<hr/>

## Menu bar functions for DVD VIDEO

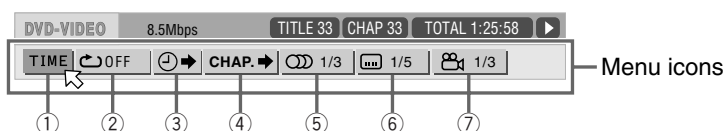

The following table shows the menu bar functions available for DVD VIDEO. Note that, in the description of the operation column, we assume the associated icon is selected.

Selected Icon	Operation	Note
① <b>TIME</b> <b>Time mode selection</b> (During playback only) Selects the time mode shown in the display window on the front panel and in the status bar.	Press ENTER to select the time mode from the following. <b>TOTAL → T.REM → TIME → REM → Return to initial</b> <ul style="list-style-type: none"> <li>• <b>TOTAL:</b> Current title elapsed time</li> <li>• <b>T.REM:</b> Current title remaining time</li> <li>• <b>TIME:</b> Current chapter elapsed time</li> <li>• <b>REM:</b> Current chapter remaining time</li> </ul>	<ul style="list-style-type: none"> <li>• If a disc has only one title and one chapter, [TOTAL] and [TIME] show the same value.</li> </ul>
② <b>Repeat mode</b> (During playback only) Selects the repeat mode.	1 Press ENTER to open the pull-down window. 2 Use ▲/▼ to select the repeat mode from the following. <b>CHAPTER ↔ TITLE ↔ A-B ↔ OFF</b> <ul style="list-style-type: none"> <li>• <b>CHAPTER:</b> Current chapter repeat</li> <li>• <b>TITLE:</b> Current title repeat</li> <li>• <b>A-B:</b> Repeats a desired part (A-B repeat)</li> </ul> 3 Press ENTER to make the selected repeat function active. (See pages 34 and 35 for details about repeat function.)	<ul style="list-style-type: none"> <li>• If you select [OFF] during repeat playback, the unit continues playback without repeating.</li> <li>• For information on subsequent operations for A-B repeat, see page 35.</li> </ul>
③ <b>Time search</b> Specifies a time from the beginning of the current title as the point from which to begin playback.	1 Press ENTER to open the pull-down window. 2 Use numeric buttons to enter a desired time. 3 Press ENTER to begin playback from the specified time. (See page 29 for details about the time search.)	
④ <b>CHAP.</b> <b>Chapter search</b> (During playback only) Specifies a desired chapter to be playback from.	1 Press ENTER to open the pull-down window. 2 Use numeric buttons to enter a desired chapter number. <ul style="list-style-type: none"> <li>• For example, to enter "12," press "1" then "2."</li> </ul> 3 Press ENTER to begin playback from the specified chapter. <ul style="list-style-type: none"> <li>• When the chapter number is incorrect: Overwrite the incorrect number with the correct number.</li> </ul>	<ul style="list-style-type: none"> <li>• The "10" and "+10" buttons are not used in this function.</li> <li>• You can also locate a desired chapter directly by specifying the chapter number using the numeric buttons during playback. See page 24.</li> </ul>
⑤ <b>Audio selection</b> (During playback only) Selects the audio language or sound track.	1 Press ENTER to open the pull-down window. 2 Use ▲/▼ to select a desired audio language or sound track. <b>Example:</b> <b>1/3 ENGLISH ↔ 2/3 FRENCH ↔ 3/3 SPANISH</b> 3 Press ENTER to begin playback with the selected audio. (See page 37 for details about audio selection.)	<ul style="list-style-type: none"> <li>• For DVD VIDEO, the selected language may be abbreviated on the TV screen. See "Table of languages and their abbreviations" on page 58.</li> </ul>
⑥ <b>Subtitle selection</b> (During playback only) Selects the subtitle language.	1 Press ENTER to open the pull-down window. 2 Use ▲/▼ to select a desired subtitle language. <b>Example:</b> <b>1/3 ENGLISH ↔ 2/3 FRENCH ↔ 3/3 SPANISH ↔ -/3 OFF</b> 3 Press ENTER to begin playback with the selected subtitle. (See page 36 for details about subtitle selection.)	
⑦ <b>Angle selection</b> (During playback only) Selects a desired scene angle in a multi-angle part.	1 Press ENTER to open the pull-down window. 2 Use ▲/▼ to select a scene angle. <b>Example:</b> <b>1/3 ↔ 2/3 ↔ 3/3</b> 3 Press ENTER to begin playback with the selected scene angle. (See page 38 for details about angle selection.)	

## Menu bar functions for SVCD/Video CD/Audio CD

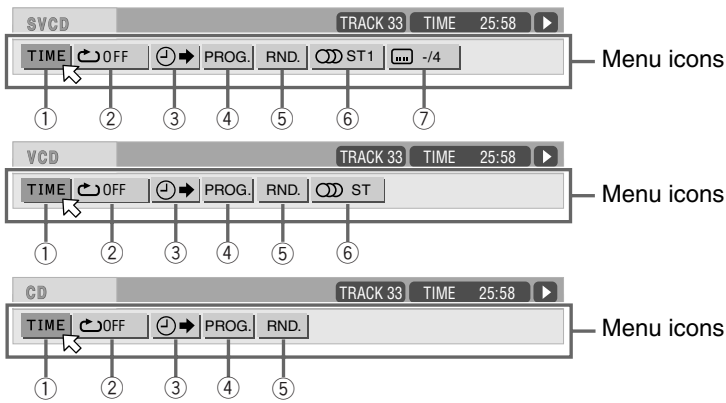

The following table shows the menu bar functions available for SVCD/Video CD/Audio CD.

Note that, in the description of the operation column, we assume the associated icon is selected.

Selected Icon	Operation	Note
<p>① <b>TIME</b></p> <p><b>Time mode selection</b> Selects the time mode shown in the display window on the front panel and in the status bar.</p>	<p>Press ENTER to select the time mode among the followings.  <b>TIME → REM → TOTAL → T.REM → Return to initial</b></p> <ul style="list-style-type: none"> <li>• <b>TIME:</b> Current track elapsed time</li> <li>• <b>REM:</b> Current track remaining time</li> <li>• <b>TOTAL:</b> Disc elapsed time</li> <li>• <b>T.REM:</b> Disc remaining time</li> </ul>	<ul style="list-style-type: none"> <li>• When you have selected [REM] and the disc is stopped, you can change the track by pressing ◀◀ or ▶▶.</li> <li>• While the disc is stopped, [REM] shows the total time of the current track, and [T.REM] shows the total time of the disc.</li> </ul>
<p>② <b>REPEAT</b></p> <p><b>Repeat mode</b> Selects the repeat mode.</p>	<ol style="list-style-type: none"> <li>1 Press ENTER to open the pull-down window.</li> <li>2 Use ▲/▼ to select the repeat mode from the following.  <b>OFF ↔ TRACK ↔ ALL ↔ A-B ↔ OFF</b> <ul style="list-style-type: none"> <li>• <b>TRACK:</b> Current track repeat</li> <li>• <b>ALL:</b> All track repeat</li> <li>• <b>A-B:</b> Repeats a desired part (A-B repeat)</li> </ul> </li> <li>3 Press ENTER to make the selected repeat function active. (See pages 34 and 35 for details about repeat function.)</li> </ol>	<ul style="list-style-type: none"> <li>• If you select [OFF] during repeat playback, the unit continues playback without repeating.</li> <li>• For information on subsequent operations for A-B repeat, see page 35.</li> </ul>
<p>③ <b>TIME SEARCH</b></p> <p><b>Time search</b> (Except during SVCD/Video CD playback with PBC) Specifies a time from the beginning of the current disc as the point from which to begin playback.</p>	<ol style="list-style-type: none"> <li>1 Press ENTER to open the pull-down window.</li> <li>2 Use numeric buttons to enter a desired time.</li> <li>3 Press ENTER to begin playback from the specified time. (See page 29 for details about the time search.)</li> </ol>	<ul style="list-style-type: none"> <li>• This function cannot be used during program playback.</li> </ul>
<p>④ <b>PROG.</b></p> <p><b>Program</b> (While stopped only) Specifies the playback order of tracks.</p>	<ol style="list-style-type: none"> <li>1 Press ENTER to bring up the program table.</li> <li>2 Specify tracks in the desired order using the numeric buttons.</li> <li>3 Press ▶ to start program playback. (See page 32 for details about the program.)</li> </ol>	_____
<p>⑤ <b>RND.</b></p> <p><b>Random</b> (While stopped only) Activates random playback.</p>	<ol style="list-style-type: none"> <li>1 Press ENTER to activate random playback. (See page 34 for details about random.)</li> </ol>	_____
<p>⑥ <b>ODD</b></p> <p><b>Audio selection</b> (During SVCD/Video CD playback only) Selects the audio channel(s).</p>	<ol style="list-style-type: none"> <li>1 Press ENTER to open the pull-down window.</li> <li>2 Use ▲/▼ to select a desired audio channel(s).</li> <li>3 Press ENTER to playback with the selected audio channel(s). (See page 37 for details about audio selection.)</li> </ol>	_____
<p>⑦ <b>SUBTITLE</b></p> <p><b>Subtitle selection</b> (During SVCD playback only) Selects the subtitle.</p>	<ol style="list-style-type: none"> <li>1 Press ENTER to open the pull-down window.</li> <li>2 Use ▲/▼ to select a desired subtitle.</li> <li>3 Press ENTER to begin playback with the selected subtitle. (See page 36 for details about subtitle selection.)</li> </ol>	_____



# MP3 disc playback

The unit can play back MP3 files on a personally recorded CD-R/RW disc or commercial CD. We refer to a disc that contains MP3 file as an "MP3 disc" in this manual.

Though functions available with MP3 discs are limited, operations for the available functions are similar to those for Audio CD discs.

Note that if a disc contains both of MP3 and JPEG files, you can only play back files of the type selected by the MP3/JPEG setting in the PICTURE preference display (see page 59).

## What is MP3?

"MP3" stands for "MPEG Audio Layer-3," and is a part of the MPEG standard. It can store high quality stereo audio using very little space by only saving the audible sounds and discarding the sounds your ears won't pick up. A CD can store up to around 10 hours of MP3 audio, which is nearly 10 times as much as an Audio CD.

### NOTE

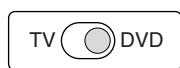

Make sure that the TV - DVD switch on the remote control unit is set to "DVD" when using the ▲/▼/◀▶ and numeric buttons for controlling the unit.

## About MP3 discs

On an MP3 disc, each song is recorded as a file. Files are sometimes grouped into folders by artists, album, category, etc. Folders can exist within other folders, creating hierarchical layers of folders. If you are familiar with personal computers, the hierarchical file and folder structure of an MP3 disc will be familiar to you as well. This unit simplifies the hierarchical structure of a disc and manages files and folders using "Tracks" and "Groups," in the following manner.

- Each file is regarded as a Track.
- A folder which has one or more files (Tracks) is regarded as a Group.
- A folder which does not directly contain any files is ignored.
- Files which do not belong to any folder are grouped into "Group 1."
- The unit recognizes up to 150 Tracks per Group, and up to 99 Groups per disc. It ignores those exceeding the maximum numbers and cannot play them back. If there are files other than MP3 files, they also count against the 150-file total.

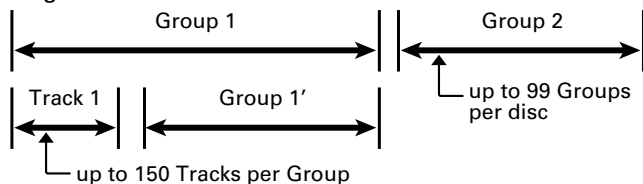

## NOTES for making your own MP3 disc using a CD-R/CD-RW disc:

- Select "ISO 9660" as the disc format.
- Finalize the disc after completing recording.
- We recommend you record your material at a 44.1 kHz sampling rate, using the 128 kbps data transfer rate.

## NOTES

- The unit does not support "packet writing" discs.
- Some tracks on an MP3 disc are skipped and may not be played back normally because of the disc configuration or characteristics determined by the writing (encoding) software and hardware used for recording. Such symptoms may occur regardless of whether using a disc you recorded or using a commercially available disc.
- The unit does not support the ID3 tag.
- If the disc is recorded with multiple sessions, the unit supports up to five sessions.
- Some discs may not play due to disc characteristics or recording conditions.
- Programmed and random playback functions do not work with MP3 discs.
- The unit only can play back Tracks with the following file extensions; ".MP3," ".Mp3," ".mp3" and ".mP3."
- Time required for reading the disc contents may vary for different discs, depending on the numbers of Groups (folders) and Tracks (files) recorded, etc.
- While an MP3 disc is loaded, you cannot bring up any preference display. (See page 57.)

## Operations

### Basic operations

Available :

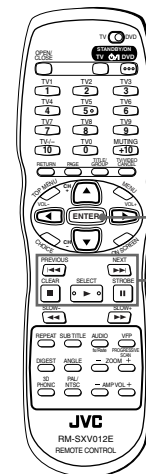

Basic control buttons

The following table shows the basic functions of the basic control buttons.

Button	Functions
	Starts playback while stopped.
	Starts playback while stopped or paused.
	Stops playback.
	Pauses playback.
	Skips back or forward a Track in the Group* during playback. Selects the previous or next Track in the Group* while stopped.

- \* You can skip a Track across a Group.
- If you press ► during playback, or press ■ to stop playback followed by ►, the unit starts playback from the beginning of the current track.
- The ▲/▼ buttons work the same as the ◀▶ buttons.

**NOTES**

- The current Group and Track numbers are shown on the display window in the following manner.

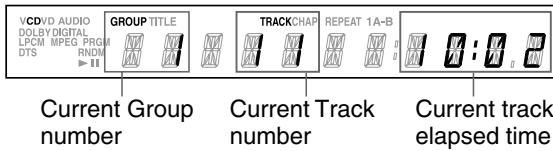

- You cannot advance or reverse playback of an MP3 disc rapidly.
- You cannot see any other time information but the current track elapsed time.

**Selecting the desired Group and Track**

Available :

When loading an MP3 disc, after the disc contents are read, the MP3 CONTROL display automatically appears on the TV screen.

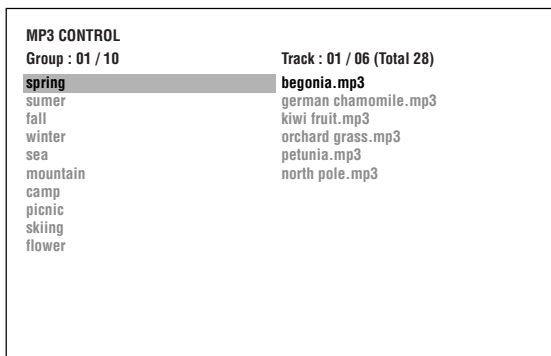

You can specify the desired Group/Track from the display using the following procedure.

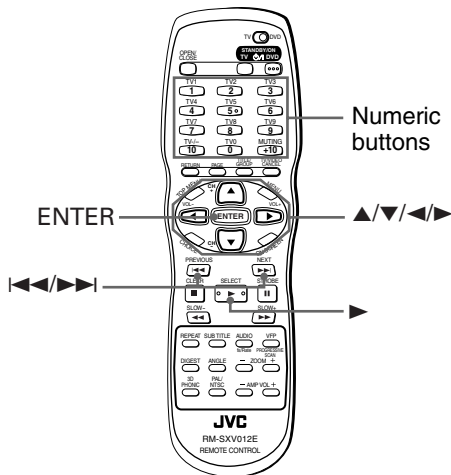

- When the MP3 CONTROL display is shown.
  - 1 Make sure that the black (cursor) bar is in the left (Group) column.
   
If it is in the right column, press ◀ to move it to the left column.
  - 2 Move the bar to a desired Group using ▲/▼.
   
On the right column, Tracks in the selected Group are shown.
   
When selecting a Group, Track 1 is initially selected (highlighted).

- 3 Select a desired Track using ◀▶, then press ENTER or ▶.
   
or
   
Use the numeric buttons to directly specify a desired Track number.

- To select a number between 1 and 10:
   
Press the corresponding button for the number.
  - To select a number higher than 10:
   
Use the +10 button.
- Examples:
- To select 13: +10 → 3
  - To select 34: +10 → +10 → +10 → 4
  - To select 40: +10 → +10 → +10 → 10

The unit starts playback from the selected Track. In the MP3 CONTROL display and the display window on the front panel, you can see the current Group and Track numbers, as well as Track elapsed time.

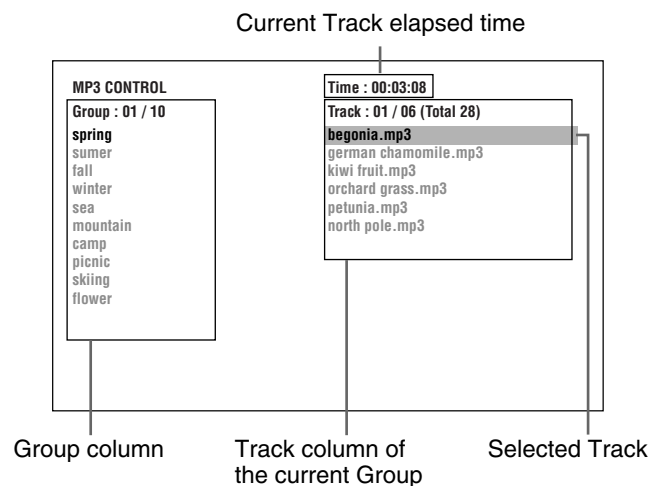

**Hint**

- You can also select a desired Track by pressing ▶ to move the black bar to the right (Track) column then using ▲/▼.

**NOTES**

- Up to 32 characters are displayed as a Group or Track name on the MP3 CONTROL display.
- If a MP3 file name includes any 2-byte character, the unit may not show the file name correctly.
- Only MP3 files are shown on the MP3 CONTROL display.
- The order of Groups/Tracks shown in the MP3 CONTROL display may differ from the order shown on your personal computer when you set the disc on your computer.

## Direct selection

Available : **MP3**

You can select a desired Group directly by specifying the Group number.

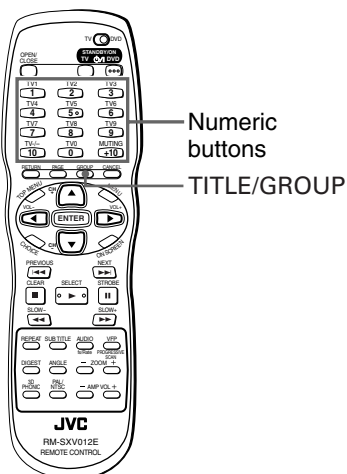

● During playback or while stopped

### 1 Press TITLE/GROUP.

[--] is shown in the Group display area of the display window.

(Front panel display window example)

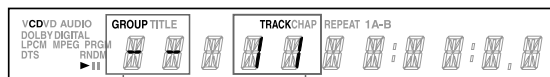

Group display area      Current track number

### 2 Use the numeric buttons to specify a desired Group number.

- To select a number between 1 and 10: Press the corresponding button for the number.
- To select a number higher than 10: Use the +10 button.

Examples:

- To select 13: +10 → 3
- To select 34: +10 → +10 → +10 → 4
- To select 40: +10 → +10 → +10 → 10

Specify the Group number within several seconds after pressing TITLE/GROUP (i.e. while the display window shows [--] for the Group number, instead of the current Group number). The unit starts playback from Track 1 of the selected Group.

### 3 Use the numeric buttons to specify a desired Track number.

The unit starts playback from the specified Track. You can also use ◀▶ or ▲▼ to specify a track, instead of the numeric buttons.

## Repeat playback

Available : **MP3**

You can repeat playback of the current Track, current Group or all MP3 files on the disc.

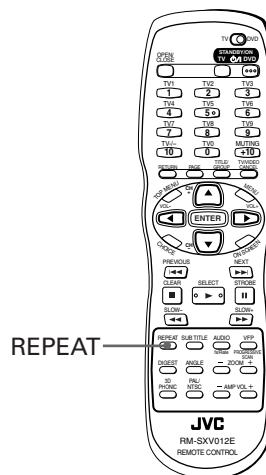

● During playback or while stopped

### 1 Press REPEAT.

Each time you press REPEAT, the repeat mode changes as follows. You can see the current mode via the display window as well as the MP3 CONTROL display.

If you press REPEAT while stopped, you need to press ENTER or ▶ to start repeat playback.

MP3 CONTROL display	Display Window	Function
REPEAT TRACK	REPEAT 1	Repeats the current Track.
REPEAT GROUP	REPEAT	Repeats all Tracks in the current Group.
REPEAT ALL	REPEAT	Repeats all Tracks on the disc.
No indication		The repeat mode is off.

(TV screen)

Selected repeat mode

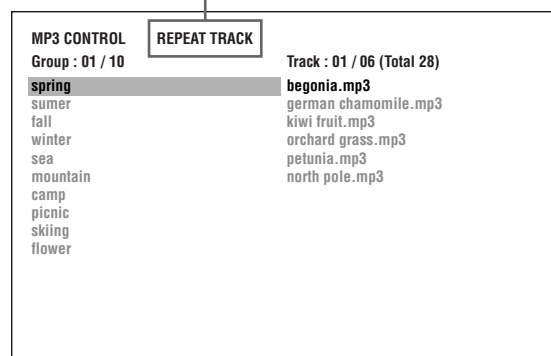

(Display window)



Repeat mode indicator

- **To stop repeat playback**  
Press **■**. Note that the repeat mode remains active.
- **To quit repeat playback**  
During playback, press REPEAT until no repeat icon is shown on the display window.  
While stopped, press REPEAT until repeat mode indication on the MP3 CONTROL display goes off.

## Checking the sampling frequency and bit rate

Available : **MP3**

You can check the sampling frequency and bit rate of digital audio during playback.

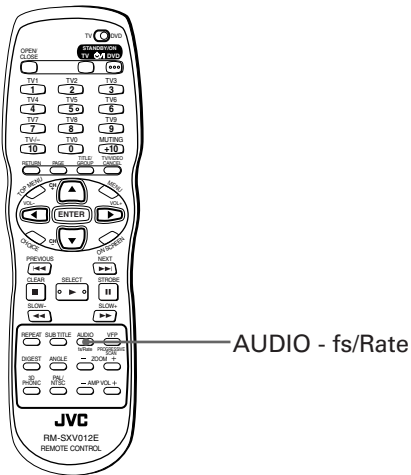

- During playback

- 1 Press and hold down AUDIO - fs/Rate for a few seconds.  
The sampling frequency and bit rate of the current digital audio are shown in the display window temporarily.

(Example)

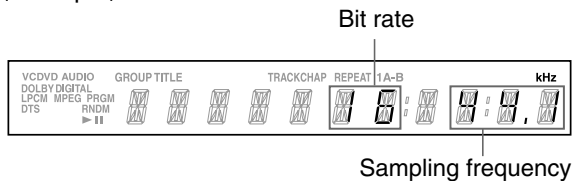

Note that any figure below the first decimal place is omitted in the display window.

### NOTE

- With some discs, [NO INFO.] may appear instead of the sampling frequency and bit rate.

# JPEG disc playback

The unit can play back JPEG files on a personally recorded CD-R/RW disc. We refer to a disc that contains JPEG files as a "JPEG disc" in this manual.

Note that if a disc contains both of MP3 and JPEG files, you can only play back files of the type selected by the MP3/JPEG setting in the PICTURE preference display (see page 59).

## What is JPEG?

"JPEG" is an abbreviation for the Joint Photographic Experts Group. "JPEG" is used to refer to an image file format that utilizes a certain compression technique. There are three sub-types of the JPEG format as follows.

- baseline JPEG: used for digital cameras, the web, etc.
- progressive JPEG: used for the web
- lossless JPEG: an old type, rarely used now

The unit supports only the baseline JPEG format; Therefore, it cannot display pictures saved in the progressive or lossless formats. If a JPEG disc contains JPEG files of non-baseline type, the unit recognizes those files as JPEG files, the JPEG CONTROL display and the display window shows the information of the contents (filename, file number, etc.), but you cannot show the still pictures of those files (the TV screen appears only in black).

## NOTE



Make sure that the TV - DVD switch on the remote control unit is set to "DVD" when using the ▲/▼/◀/▶, numeric buttons for controlling the unit.

## About JPEG discs

On a JPEG disc, each picture is recorded as a file. Files are sometimes grouped into folders by category, etc. Folders can exist within other folders, creating hierarchical layers of folders. If you are familiar with personal computers, the hierarchical file and folder structure of a JPEG disc will be familiar to you as well. This unit simplifies the hierarchical structure of a disc and manages folders using "Groups," in the following manner.

- A folder which has one or more files is regarded as a Group.
- A folder which does not directly contain any files is ignored.
- Files which do not belong to any folder are grouped into "Group 1."
- The unit recognizes up to 150 files per Group, and up to 99 Groups per disc. It ignores those exceeding the maximum numbers and cannot display them. If there are files other than JPEG files, they also count against the 150-file total.

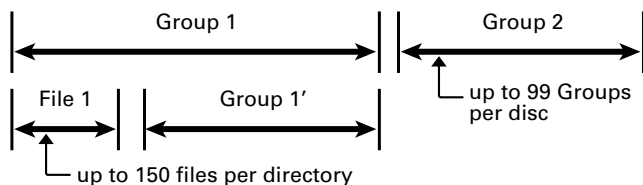

## NOTES for making your own JPEG disc using a CD-R/CD-RW disc:

- Select "ISO 9660" as the disc format.
- Finalize the disc after completing recording.
- We recommend you record your material at a 640 x 480 pixel resolution.
- This unit supports only the baseline JPEG format. Therefore, it cannot display pictures saved in the progressive or lossless formats. If a JPEG disc contains JPEG files of non-baseline type, the unit recognizes those files as JPEG files. The JPEG CONTROL display and the display window show the information of the contents (filename, file number, etc.), but you cannot show the still pictures of those files (the TV screen appears only in black).

## NOTES

- The unit does not support "packet writing" discs.
- If the disc is recorded with multiple sessions, the unit supports up to five sessions.
- The unit may not be able to read some discs, or may take a long time to display a picture on the disc, due to disc characteristics or recording conditions.
- Programmed and random playback functions do not work with JPEG discs.
- The screen saver function will be activated if the same picture is displayed for more than 5 minutes except during slide show playback (see page 54).
- The unit only can play back files with the following file extensions; ".jpg," ".jpeg," ".JPG," ".JPEG" and any other combination of upper case and lower case letters (such as ".Jpg").
- If a JPEG file name includes any 2-byte character, the unit may not show the file name correctly.
- If a picture has been saved at greater than 640 x 480 pixel resolution, it may take some time to display the picture.
- The unit will not accept any commands (stopping playback, zooming into or out of an image, etc.) while in the process of displaying a picture.
- The time required to read the disc contents may vary for different discs, depending on the numbers of Groups (folders) and files recorded, etc.
- If you attempt to display a non-baseline JPEG image: The unit will not be able to display the picture (the TV screen will be black). Other operations (stopping display, selecting a file, etc.) will be possible, but may take a long time.
- While a JPEG disc is loaded, you cannot bring up any preference display (see page 57).
- This unit does not support pixel size picture of more than 2400 pixels. Make sure that the picture pixel size is 2400 pixels or less.

# Basic operations

## To see a desired picture

Available : **JPEG**

When loading a JPEG disc, after the disc contents are read, the JPEG CONTROL display automatically appears on the TV screen.

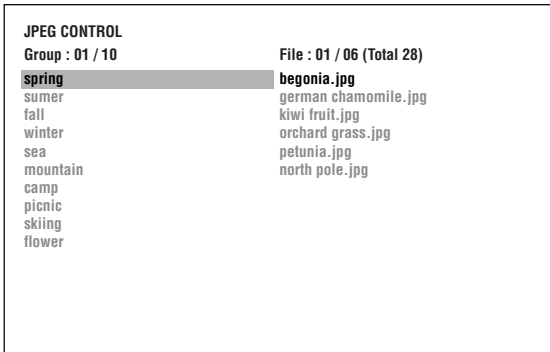

You can select a desired file for playback via this display.

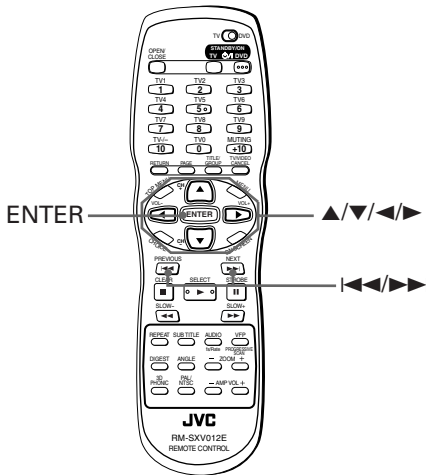

• When the JPEG CONTROL display is shown

**1** Make sure that the black (cursor) bar is in the left (Group) column.

If it is in the right column, press ◀ to move it to the left column.

**2** Move the bar to a desired Group using ▲/▼. On the right column, files in the selected Group are shown. When selecting a Group, File 1 is initially selected (highlighted).

**3** Select a desired file using ◀▶▶▶.

**4** Press ENTER.

The selected file (still picture) is shown on the TV. In the display window, you can see the current Group and File numbers.

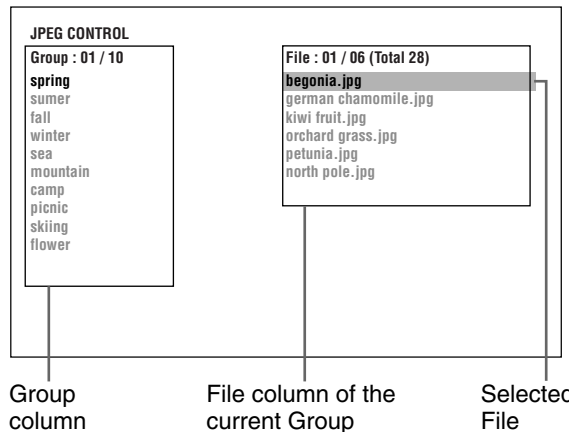

### Hints

- You can also select a desired file by pressing ▶ to move the black bar to the right (File) column then using ▲/▼.
- To return the black bar to the Group column, press ◀.

### To display another picture:

Use ◀▶▶▶ or ▲/▼ to select the desired picture. You can select a picture in another Group.

### To dismiss the picture:

Press ■ or MENU.

The TV screen returns to showing the JPEG CONTROL display.

### NOTES

- Up to 32 characters are displayed as a group or file name on the JPEG CONTROL display.
- The current Group and File number are also shown on the display window in the following manner.

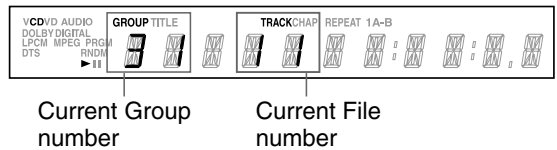

- Only JPEG files are shown on the display window.

## To zoom in or out the pictures [ZOOM]

Available : **JPEG**

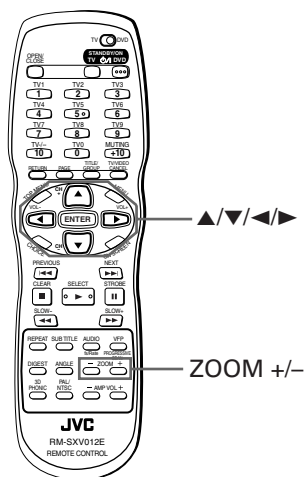

### NOTES

- You can zoom into or out of a picture in slide show mode if the show is paused (see next page).
- To return to a normal screen: Press ENTER.
- The zoom information on the screen will disappear if you do not operate the zoom function for 5 seconds.
- The image may look coarse when a zoomed image is displayed.

- While a JPEG image is displayed on the TV screen

### 1 Press ZOOM + or -.

Pressing ZOOM + causes the unit to zoom in on the image, and pressing ZOOM - causes the unit to zoom out.

Each time you press ZOOM +, the magnification is doubled (up to 1024 times).

Each time you press ZOOM -, the magnification is halved (down to 1/8 times).

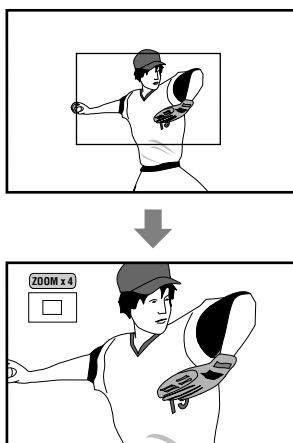

At the top left of the screen, the information for the current magnification appears for 5 seconds. While zoomed in, an indication of the zoomed image position is also displayed. The next step can be used to move the image position.

### 2 Use ▲/▼/◀/▶ to move the zoomed position.

If no button pressed for 5 seconds, the information for the current magnification disappears.

To display the information, press ZOOM +/- or ▲/▼/◀/▶ again.

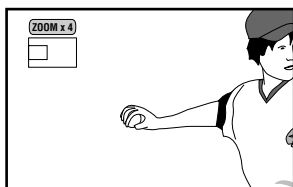

## To see pictures continuously [slide show mode]

You can see Files (still pictures) one after another automatically in the slide show mode. In this mode, each File (still picture) is displayed for approximately 3 seconds. The next File will then be displayed.

### Playback features

Available : **JPEG**

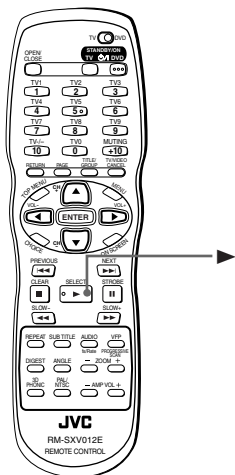

- After inserting a JPEG disc

#### 1 Press ►.

The slide show starts from the beginning of the disc.

#### NOTES

- **To stop slide show playback (to dismiss the picture) in the middle of slide show playback:**  
Press ■ or MENU.  
The TV screen returns to showing the JPEG CONTROL display.  
Pressing ► resumes slide show playback from the last picture displayed.
- **To keep showing the current picture while in slide show mode:**  
Press ■ or ENTER.  
The picture does not change to the next picture.  
Pressing ► resumes the slide show playback from the next picture.
- **If a black screen appears continuously in the slide show playback:**  
The File currently displayed may be non-baseline JPEG file. In this case, select a playable File (a baseline JPEG file) again (e.g., pressing ■ or MENU to open the JPEG CONTROL display, etc).  
Note that it may take a long time to select another File.

## Selecting the start point of the slide show

Available : **JPEG**

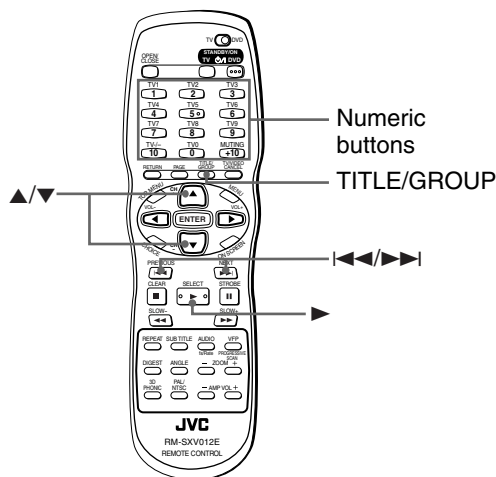

### From the JPEG CONTROL display

- While the JPEG CONTROL display is shown

- 1 Make sure that the black (cursor) bar is in the left (Group) column.  
If it is in the right column, press ◀ to move it to the left column.

JPEG CONTROL	
Group : 01 / 10	File : 01 / 06 (Total 28)
<b>spring</b>	<b>begonia.jpg</b>
summer	german chamomile.jpg
fall	kiwi fruit.jpg
winter	orchard grass.jpg
sea	petunia.jpg
mountain	north pole.jpg
camp	
picnic	
skiing	
flower	

- 2 Move the bar to a desired Group using ▲/▼.  
In the right column, files in the selected Group are shown.  
When selecting a Group, File 1 is initially selected (highlighted).
- 3 Select a desired file using ◀◀◀/▶▶▶.
- 4 Press ►.  
The slide show starts from the specified File.

JPEG disc playback



## Direct selection

- During playback or while stopped

### 1 Press TITLE/GROUP.

[--] is shown in the Group display area of the display window.

(Front panel display window example)

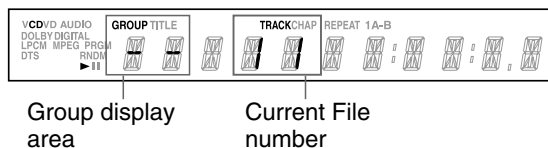

### 2 Use the numeric buttons to specify a desired Group number.

- To select a number between 1 and 10:  
Press the corresponding button for the number.
- To select a number higher than 10:  
Use the +10 button.

Examples:

To select 13: +10 → 3

To select 34: +10 → +10 → +10 → 4

To select 40: +10 → +10 → +10 → 10

Specify the Group number within several seconds after pressing TITLE/GROUP (i.e. while the display window shows [--] for the Group number, instead of the current Group number).

### 3 Use the numeric buttons to specify a desired file number.

You can specify the file number according to the order in the JPEG CONTROL display. You must specify a file number within 5 seconds after carrying out step 2.

The unit starts slide show playback from the specified File. If you do not specify a file number, the unit starts slide show playback from the first File in the Group.



- You can skip a File in the slide show by using ◀◀/▶▶ or ▲/▼.
- You can select a File in the current Group by using the numeric buttons.

## NOTES

- **To stop slide show playback (to dismiss the picture) in the middle of slide show playback:**  
Press ■ or MENU.  
The TV screen returns to showing the JPEG CONTROL display.  
Pressing ▶ resumes slide show playback from the last picture you displayed.
- **To keep showing the current picture while in slide show mode:**  
Press II or ENTER.  
The picture does not change to the next picture.  
Pressing ▶ resumes the slide show playback from the next picture.
- **If a black screen appears continuously in the slide show playback:**  
The file currently displayed may be non-baseline JPEG file. In this case, select a playable File (a baseline JPEG file) again (e.g., pressing ■ or MENU to open the JPEG CONTROL display, etc.).  
Note that it may take a long time to select another File.

## Repeat function

on the JPEG CONTROL display goes off.

Available : **JPEG**

In the slide show mode, you can repeat playback of JPEG files in a Group or on the disc.

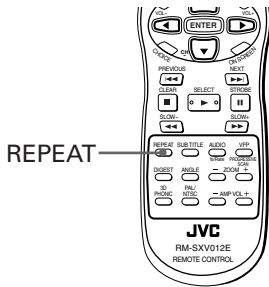

- While the JPEG CONTROL display is shown

### 1 Press REPEAT.

Pressing REPEAT switch the repeat mode.

If you press REPEAT while the JPEG CONTROL display is shown, you need to press ► to start repeat playback.

The selected mode is reflected by an icon displayed in the front panel display window, and by the mode name shown in the JPEG CONTROL display, as described below.

JPEG CONTROL display	Display Window	Function
REPEAT ALL	REPEAT	All Files on the disc are repeated.
REPEAT GROUP		All Files in the current Group are repeated.
No indication		The repeat mode is off.

(TV Screen)

Selected repeat mode

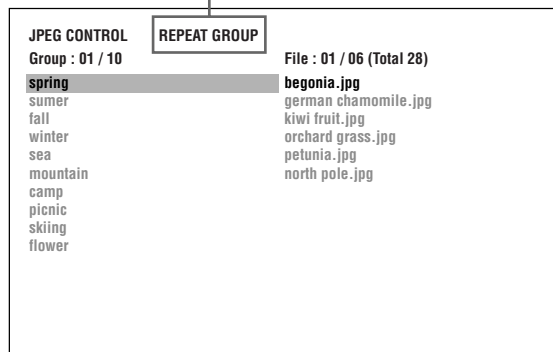

(Display window)



Repeat mode indicator

- **To stop repeat playback**  
Press ■ . Note that the repeat mode remains active.
- **To quit repeat playback**  
Press ■ or MENU while the JPEG CONTROL display is shown, press REPEAT until the repeat mode indication

# Changing the initial settings

## NOTE



Make sure that the TV - DVD switch on the remote control unit is set to "DVD" when using the ▲/▼/◀/▶ and numeric buttons for controlling the unit.

## Selecting preferences

This chapter refers to the settings which are already made when you purchase the unit. Read this section when you want to connect this machine to a wide-vision TV set, or when you want to otherwise change the settings according to your preferences and viewing environment.

## About the Preference display

The preference display consists of the LANGUAGE, PICTURE, AUDIO, SPK.SETTING and OTHERS setting displays, each having setting items.

### • LANGUAGE

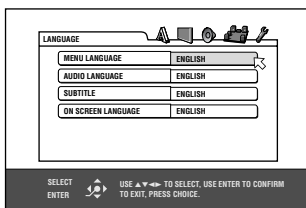

### • PICTURE

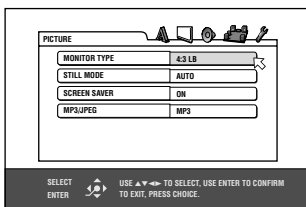

### • AUDIO

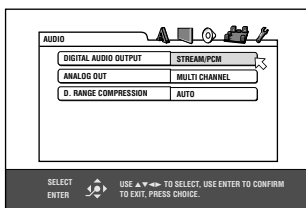

### • SPK.SETTING

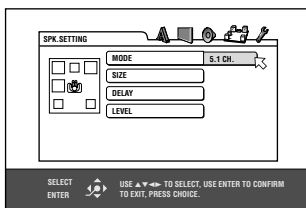

### • OTHERS

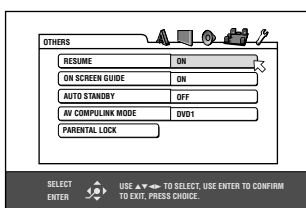

## How to set preferences

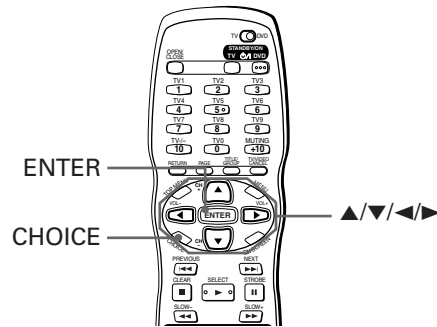

### • While stopped

#### 1 Press CHOICE.

One of the Preference on-screen displays appears on the TV screen. You can see four icons at the top right of the on-screen display for the settings.

- : Language menu
- : Picture menu
- : Audio menu
- : Setting menu for speakers
- : Others menu (system setting)

#### 2 Select the appropriate icon using ◀/▶.

The appropriate display appears on the TV screen.

#### 3 Move ↗ to select the item you want to edit using ▲/▼.

The color of the selected item changes.

#### 4 Press ENTER.

A pull-down menu appears over the selected item.

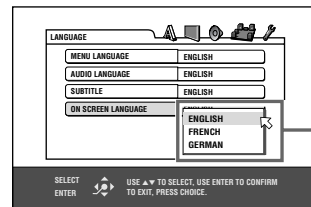

Selected item

#### 5 Press ▲/▼ to select from the options and press ENTER.

The selected option is set.

- For details about each setting, see the following.

## NOTES

- To dismiss a preference display: Press CHOICE.
- While an MP3 or JPEG disc is loaded, you cannot bring up any preference display.
- When a preference display is shown on a wide TV screen, the upper and lower parts of the TV picture sometimes may be cut off. If this happens, adjust the picture size control of the TV.

# LANGUAGE menu

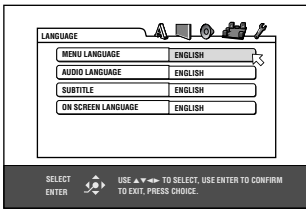

This menu allows you to select the languages used for DVD AUDIO/DVD VIDEO playback, as well as the on-screen display language of the unit.

**NOTE**

- During playback, you can bring up any menu of the preference displays; however, only [ON SCREEN LANGUAGE] can be set on the [LANGUAGE] menu.

Menu item	Setting options	Notes/examples
<b>MENU LANGUAGE</b> You can select the default menu language to be displayed if it is contained on a DVD AUDIO/DVD VIDEO disc.	<b>ENGLISH ↔ SPANISH ↔ FRENCH ↔ CHINESE ↔ GERMAN ↔ ITALIAN ↔ JAPANESE ↔ language code from AA to ZU</b>	<ul style="list-style-type: none"> <li>• If the disc does not have a menu in the selected language, the disc's default language will be used.</li> <li>• For details about language codes, see "Table of languages and their abbreviations" at the bottom of this page.</li> </ul>
<b>AUDIO LANGUAGE</b> You can select the default audio language to be played if it is contained on a DVD AUDIO/DVD VIDEO disc.		
<b>SUBTITLE</b> You can select the default subtitle language to be displayed if it is contained on a DVD AUDIO/DVD VIDEO disc.		
<b>ON SCREEN LANGUAGE</b> You can select the on-screen display language of the unit.	<b>ENGLISH ↔ FRENCH ↔ GERMAN</b>	English <input type="text" value="ON SCREEN LANGUAGE"/> <input type="text" value="ENGLISH"/> French <input type="text" value="LANGUE D' ECRAN"/> <input type="text" value="FRANCAIS"/> German <input type="text" value="BILDSCHIRMENÜ-SPRACHE"/> <input type="text" value="DEUTSCH"/> <ul style="list-style-type: none"> <li>• Some on-screen messages are shown in English regardless of the setting.</li> <li>• You cannot change the on-screen language shown on the MP3 and JPEG CONTROL displays.</li> </ul>



## Table of languages and their abbreviations

AA	Afar	FA	Persian	KM	Cambodian	OM	(Afan) Oromo	SU	Sundanese
AB	Abkhazian	FI	Finnish	KN	Kannada	OR	Oriya	SV	Swedish
AF	Afrikaans	FJ	Fiji	KO	Korean (KOR)	PA	Panjabi	SW	Swahili
AM	Ameharic	FO	Faroese	KS	Kashmiri	PL	Polish	TA	Tamil
AR	Arabic	FY	Frisian	KU	Kurdish	PS	Pashto, Pushto	TE	Telugu
AS	Assamese	GA	Irish	KY	Kirghiz	PT	Portuguese	TG	Tajik
AY	Aymara	GD	Scots Gaelic	LA	Latin	QU	Quechua	TH	Thai
AZ	Azerbaijani	GL	Galician	LN	Lingala	RM	Rhaeto-Romance	TI	Tigrinya
BA	Bashkir	GN	Guarani	LO	Laothian	RN	Kirundi	TK	Turkmen
BE	Byelorussian	GU	Gujarati	LT	Lithuanian	RO	Rumanian	TL	Tagalog
BG	Bulgarian	HA	Hausa	LV	Latvian, Lettish	RU	Russian	TN	Setswana
BH	Bihari	HI	Hindi	MG	Malagasy	RW	Kinyarwanda	TO	Tongan
BI	Bislama	HR	Croatian	MI	Maori	SA	Sanskrit	TR	Turkish
BN	Bengali, Bangla	HU	Hungarian	MK	Macedonian	SD	Sindhi	TS	Tsonga
BO	Tibetan	HY	Armenian	ML	Malayalam	SG	Sangho	TT	Tatar
BR	Breton	IA	Interlingua	MN	Mongolian	SH	Serbo-Croatian	TW	Twi
CA	Catalan	IE	Interlingue	MO	Moldavian	SI	Singhalese	UK	Ukrainian
CO	Corsican	IK	Inupiak	MR	Marathi	SK	Slovak	UR	Urdu
CS	Czech	IN	Indonesian	MS	Malay (MAY)	SL	Slovenian	UZ	Uzbek
CY	Welsh	IS	Icelandic	MT	Maltese	SM	Samoan	VI	Vietnamese
DA	Danish	IW	Hebrew	MY	Burmese	SN	Shona	VO	Volapuk
DZ	Bhutani	JI	Yiddish	NA	Nauru	SO	Somali	WO	Wolof
EL	Greek	JW	Javanese	NE	Nepali	SQ	Albanian	XH	Xhosa
EO	Esperanto	KA	Georgian	NL	Dutch	SR	Serbian	YO	Yoruba
ET	Estonian	KK	Kazakh	NO	Norwegian	SS	Siswati	ZU	Zulu
EU	Basque	KL	Greenlandic	OC	Occitan	ST	Sesotho		

# PICTURE menu

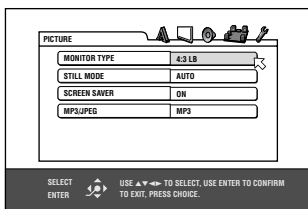
This menu allows you to select options having to do with picture quality or the monitor screen.

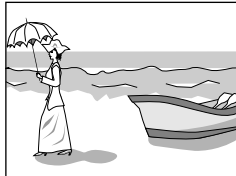

Menu item	Setting options	Notes/examples
<b>MONITOR TYPE</b> You can select the monitor type to match your TV when you playback DVD VIDEO discs recorded for wide-screen televisions.	<ul style="list-style-type: none"> <li>• <b>16:9 NORMAL (Wide Television screen)</b> Should be selected when you connect the unit to a wide-screen (16:9) TV whose aspect ratio is set to 16:9 (the unit automatically adjusts the screen width of the output signal correctly when playing back a 4:3 source).</li> </ul>	 <ul style="list-style-type: none"> <li>• If you play a 4:3 DVD VIDEO source using the [16:9 NORMAL] mode, the picture character changes slightly due to the process for converting the picture width.</li> </ul>
	<ul style="list-style-type: none"> <li>• <b>16:9 AUTO (Wide Television screen)</b> Should be selected when you connect a wide-screen (16:9) TV to the unit.</li> </ul>	
	<ul style="list-style-type: none"> <li>• <b>4:3 LB (Letter Box Conversion)</b> Should be selected when you connect a normal (4:3) TV to the unit. When playing back a DVD VIDEO disc recorded in wide picture format, the picture is shown with black bars at the top and bottom.</li> </ul>	
	<ul style="list-style-type: none"> <li>• <b>4:3 PS (Pan Scan Conversion)</b> Should be selected when you connect a normal (4:3) TV to the unit. When playing back a DVD VIDEO disc recorded in wide picture format, the picture is zoomed to fill the screen vertically, and the left and right sides of the image are chopped off.</li> </ul>	 <ul style="list-style-type: none"> <li>• With some discs recorded in wide picture format, the picture will be shown in the 4:3 LB mode even if you select the 4:3 PS mode.</li> </ul>
<b>STILL MODE</b> This mode selects whether the content on the disc is processed by field or by frame. If set to AUTO, the decision of how to process the content is made automatically, based on data and flags recorded on the disc.	<ul style="list-style-type: none"> <li>• <b>AUTO</b> The unit recognizes the picture type (film or video source) of the current disc.</li> </ul>	<ul style="list-style-type: none"> <li>• Normally, set to [AUTO].</li> <li>• When Progressive scanning mode is active, the PROGRESSIVE indicator is lit. Note that the color of indication changes depending on this setting, source type and the unit's status (see pages 9 and 10).</li> <li>• Some DVD VIDEO discs may not play correctly if AUTO is selected. If the picture is unclear or noisy with a particular DVD VIDEO disc, try changing the mode.</li> </ul>
	<ul style="list-style-type: none"> <li>• <b>FIELD</b> Suitable for playing back a video source disc.</li> </ul>	
	<ul style="list-style-type: none"> <li>• <b>FRAME</b> Suitable for playing back a film source disc.</li> </ul>	
<b>SCREEN SAVER</b> You can set the screen saver function ON or OFF. See page 19 for details about the screen saver function.	<ul style="list-style-type: none"> <li>• <b>ON</b> The current picture gets dark.</li> </ul>	<ul style="list-style-type: none"> <li>• The screen saver function does not work for still images during DVD AUDIO playback.</li> </ul>
	<ul style="list-style-type: none"> <li>• <b>OFF</b> The screen saver function is off.</li> </ul>	
<b>MP3/JPEG</b> The unit can play MP3 and JPEG files recorded on a CD-R/CD-RW disc. However, if a disc contains both MP3 and JPEG files, you can only play files of the type selected in this menu item.	<ul style="list-style-type: none"> <li>• <b>MP3</b> Only MP3 files can be played back if a disc contains both MP3 and JPEG files.</li> </ul>	<ul style="list-style-type: none"> <li>• When a disc contains either only MP3 files or only JPEG files, the unit can play back the files regardless of the setting.</li> </ul>
	<ul style="list-style-type: none"> <li>• <b>JPEG</b> Only JPEG files can be played back if a disc contains both MP3 and JPEG files.</li> </ul>	

Changing the initial settings

## AUDIO menu

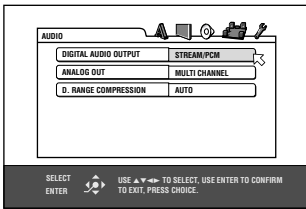

This menu allows you to select desired options concerning with audio sound.

Menu item	Setting options	Notes/examples
<b>DIGITAL AUDIO OUTPUT</b> To connect the unit's digital output to an external device equipped with a digital input, this item must be set correctly. See the table following for details about the relation between the setting and output signals.	<ul style="list-style-type: none"> <li>• <b>PCM ONLY</b> Should be selected when you connect the DIGITAL OUT jack of the unit to the linear PCM digital input of other audio equipment.</li> </ul>	<ul style="list-style-type: none"> <li>• When playing a DVD VIDEO or Audio CD disc with DTS, use a DTS decoder to get correct signals from your speakers.</li> <li>• With some DVD VIDEO discs that are not fully copy-protected, a 20 or 24 bit digital signal may be output.</li> <li>• A signal recorded with the 88.2 kHz or higher sampling frequency cannot be output from the DIGITAL OUT jack, regardless of the setting (due to copy protection issues).</li> </ul>
	<ul style="list-style-type: none"> <li>• <b>DOLBY DIGITAL/PCM</b> Should be selected when you connect the digital input of a Dolby Digital decoder or an amplifier with a built-in Dolby Digital decoder. When this option is selected, playing back a disc recorded by the DTS or MPEG Multichannel format outputs a linear PCM digital signal.</li> </ul>	
	<ul style="list-style-type: none"> <li>• <b>STREAM/PCM</b> Should be selected when you connect the digital input of an amplifier with a built-in DTS, MPEG Multichannel or Dolby Digital decoder, or the stand-alone unit of such a decoder.</li> </ul>	

### Digital output signal chart

Disc type	Output		
	PCM ONLY	DOLBY DIGITAL/PCM	STREAM/PCM
DVD with 48/44.1 kHz, 16/20/24 bit linear PCM	48/44.1 kHz, 16 bit, stereo linear PCM		
DVD with 192/176.4/96/88.2 kHz, 16/22/24 bit linear PCM	No output		
DVD with DTS	48 kHz, 16 bit, stereo linear PCM		DTS bitstream
DVD with Dolby Digital	48 kHz, 16 bit, stereo linear PCM	Dolby Digital bitstream	
DVD with MPEG Multichannel	48 kHz, 16 bit, stereo linear PCM		MPEG bitstream
Audio CD/Video CD/SVCD	44.1 kHz, 16 bit, stereo linear PCM		
Audio CD with DTS	44.1 kHz, 16 bit, stereo linear PCM		DTS bitstream
CD-R/RW with MP3	Linear PCM		

Menu item	Setting options	Notes/examples
<b>ANALOG OUT</b> To play back a DVD VIDEO disc recorded with surround multichannel audio correctly, this setting must be properly made according to your audio system.	<ul style="list-style-type: none"> <li>• <b>2-CH DOLBY SURROUND</b> Should be selected when you enjoy multichannel surround audio by connecting the unit's AUDIO OUT jacks to a surround decoder.</li> </ul>	<ul style="list-style-type: none"> <li>• This function does not work when the 3D PHONIC function is activated (see page 41).</li> <li>• [2-CH DOLBY SURROUND] and [2-CH STEREO] settings affect only the output signal from the AUDIO OUT jacks when playing back a DVD VIDEO disc recorded with surround multichannel audio.</li> <li>• Some DVD AUDIO discs prohibit the 2-channel down-mix. For such a disc, you cannot get the down-mixed signal even if you set [ANALOG OUT] to [2-DOLBY SURROUND] or [2-CH STEREO].</li> </ul>
	<ul style="list-style-type: none"> <li>• <b>2-CH STEREO</b> Should be selected when you enjoy conventional 2-channel stereo audio by connecting the unit's AUDIO OUT jacks to a stereo amplifier/receiver or television set, or when you duplicate audio of a DVD VIDEO disc recorded with surround audio to your MD, cassette, etc.</li> </ul>	
	<ul style="list-style-type: none"> <li>• <b>MULTI CHANNEL</b> When you enjoy multichannel surround audio by connecting the unit's 5.1-channel audio outputs to an amplifier equipped with 5.1-channel inputs.</li> </ul>	

Menu item	Setting options	Notes/examples
<b>D. RANGE COMPRESSION</b> This setting provides optimal audio quality for listening to DVD VIDEO discs recorded in Dolby Digital format, at low or middle volume.	<ul style="list-style-type: none"> <li>• <b>AUTO</b> Audio is played back with the dynamic range compressed except when playing a disc recorded with Dolby Digital 1- or 2-channel format.</li> </ul>	<ul style="list-style-type: none"> <li>• This function works only when playing back a disc recorded with Dolby Digital. The setting does not affect audio from other discs.</li> <li>• This function does not work when the 3D PHONIC function is activated (see page 41).</li> </ul>
	<ul style="list-style-type: none"> <li>• <b>ON</b> Audio is always played back with the dynamic range compressed.</li> </ul>	

## SPK.SETTING menu

This setting allows you to select desired options concerning with the speakers.

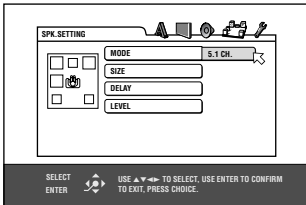

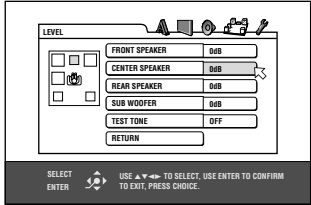

Menu item	Setting options	Notes/examples
<b>MODE</b> You can select the speaker configuration type according to your speaker systems. Normally, set to [5.1 CH.].	<ul style="list-style-type: none"> <li>• <b>5.1 CH.</b> When you connect to a 5.1-channel amplifier and use the front, rear, center and sub-woofer speakers.</li> </ul>	<ul style="list-style-type: none"> <li>• When selecting [5.1 CH.], set [ANALOG OUT] to [MULTI CHANNEL] in the [AUDIO] preference display (see page 60).</li> <li>• The signal is always fed from the SUBWOOFER jack on the rear panel of the unit when "SUBWOOFER" is selected.</li> <li>• If you connect the unit's digital output to an external Dolby Digital or DTS decoder (and set [DIGITAL AUDIO OUTPUT] to [STREAM/PCM] in the [AUDIO] preference display), the speaker settings shown left is not effective. Make the speaker settings of the external decoder properly.</li> </ul>
	<ul style="list-style-type: none"> <li>• <b>EXPERT</b> When you want to make fine tuning to match your speakers. The SIZE, DELAY, and LEVEL setting items are available.</li> </ul>	
<b>SIZE</b> You can set the speaker sizes according to your speakers.	See page 63 for details about the speaker size setting.	(SIZE display) <p>The screenshot shows the 'SIZE' menu with a cursor pointing to 'LARGE' for the FRONT SPEAKER. Other options include SMALL for CENTER and REAR SPEAKERS, and SUB WOOFER for BASS REDIRECT. A RETURN button is at the bottom. Navigation instructions are at the bottom.</p> <ul style="list-style-type: none"> <li>• When playing back a disc with either [CENTER SPEAKER] or [REAR SPEAKER] set to [NONE], the audios from the center speaker or rear speakers are output from the front speakers.</li> </ul>
<b>DELAY</b> You can set the speaker delay time according to your speakers.	See page 64 for details about the speaker delay time setting.	(DELAY display) <p>The screenshot shows the 'DELAY' menu with a cursor pointing to '0.0m' for the CENTER SPEAKER and '1.5m' for the REAR SPEAKER. A RETURN button is at the bottom. Navigation instructions are at the bottom.</p>

Menu item	Setting options	Notes/examples
<p><b>LEVEL</b> You can set the speaker output level according to your speakers.</p>	See page 64 for details about the speaker output level setting.	<p>(LEVEL display)</p> 

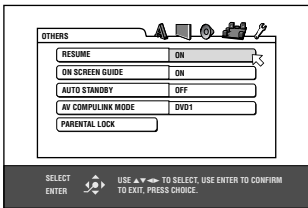
## OTHERS menu

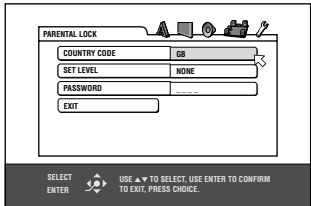

This menu allows you to set various system options.

Menu item	Setting options	Notes/examples
<p><b>RESUME</b> You can select the resume playback mode.</p>	<ul style="list-style-type: none"> <li>• <b>ON</b> The unit can resume playback of the disc from the position where play was last interrupted, if the disc is still in the tray.</li> </ul>	<ul style="list-style-type: none"> <li>• See page 21 for details about the resume playback function.</li> </ul>
	<ul style="list-style-type: none"> <li>• <b>OFF</b> The resume function is not active.</li> </ul>	
	<ul style="list-style-type: none"> <li>• <b>DISC RESUME</b> The unit can resume playback of the last 30 discs played. The unit retains a memory of the interrupt positions of the last 30 discs played, even though they have been removed from the tray.</li> </ul>	
<p><b>ON SCREEN GUIDE</b> The unit can display "on-screen guide" icons or characters on the picture, which show what is happening to the disc or the unit.</p>	<ul style="list-style-type: none"> <li>• <b>ON</b> "On-screen guide" icons will be displayed.</li> </ul>	<ul style="list-style-type: none"> <li>• See page 19 for information about "on-screen guide" icons.</li> <li>• Examples of "on-screen guide" icons or characters: , , .</li> </ul>
	<ul style="list-style-type: none"> <li>• <b>OFF</b> "On-screen guide" icons will not be displayed.</li> </ul>	
<p><b>AUTO STANDBY</b> When the unit is stopped for more than 30 minutes or 60 minutes, the unit enters standby mode automatically.</p>	60 ↔ 30 ↔ OFF	_____
<p><b>AV COMPULINK MODE</b> This item is provided for use in the future. Leave it as the default setting ([DVD 1]).</p>	_____	_____
<p><b>PARENTAL LOCK</b> When this option is selected, pressing ENTER on the remote control unit brings up to the PARENTAL LOCK display shown following. This allows you to restrict children from playing DVD VIDEO discs.</p>	See page 65 for details about the Parental Lock setting.	<p>(PARENTAL LOCK display)</p> 



## Making fine tuning for your speakers

You can make fine tuning to match your speaker system. This adjustment is available only when [ANALOG OUT] is set to [MULTI CHANNEL] in the [AUDIO] preference display and [MODE] is set to [EXPERT] in the [SPK.SETTING] preference display.

### To set the speaker sizes

You can set the speaker sizes according to your speakers.

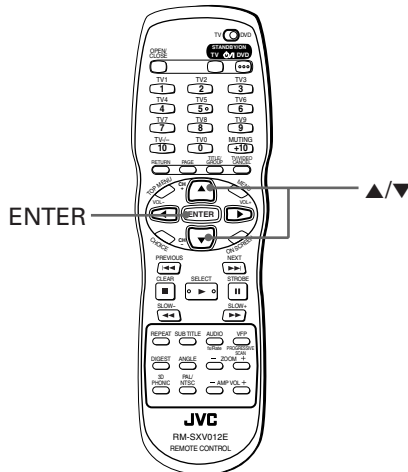

- While the [SPK.SETTING] page of the preference display is shown

- 1 Use ▲/▼ to move  to [SIZE] and press ENTER.

The SIZE display page appears on the TV screen.  
 points to [FRONT SPEAKER].

See page 61 for details about how to bring up the [SPK.SETTING] page.

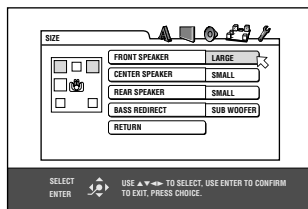

- 2 Use ▲/▼ to select the speaker to be set and press ENTER.

FRONT SPEAKER: Front speakers

CENTER SPEAKER: Center speaker

REAR SPEAKER: Rear speakers

- 3 Use ▲/▼ to select the size and press ENTER.

LARGE: Large speaker(s) which can fully reproduce the low-frequency range.

SMALL: Small speaker(s) which cannot fully reproduce the low-frequency range.

NONE: No speaker(s) connected. This option is only for [CENTER SPEAKER] and [REAR SPEAKER].

- 4 Repeat steps 2 and 3 if you set other speakers.

- To return to the [SPK.SETTING] page  
Use ▲/▼ to move  to [RETURN] and press ENTER.

#### NOTES

- If you set the [FRONT SPEAKER] to [SMALL], you cannot set the other speakers to [LARGE].
- When playing back a DVD AUDIO disc with either [CENTER SPEAKER] or [REAR SPEAKER] set to [NONE], their audio does not output from the front speakers.

### BASS REDIRECT function

When you use the small speakers which do not fully reproduce the low-frequency range, you can boost up the low-frequency signal of the subwoofer or front speakers.

- 1 Use ▲/▼ to select [BASS REDIRECT] and press ENTER.

- 2 Use ▲/▼ to select [SUB WOOFER] or [FRONT L/R] and press ENTER.

SUB WOOFER: The low-frequency signal fed from the subwoofer output is boosted up.

FRONT L/R: The low-frequency signals fed from the front speaker outputs are boosted up. However, no audios output from the subwoofer when setting to this option.

The [BASS REDIRECT] setting is effective only when at least any one of the speaker sizes is set to [SMALL]. If none of them is set to [SMALL], this setting is no activated.

([NONE] appears in the setting field.)

No audio is output from the SUBWOOFER jack when [FRONT L/R] is selected. If the front speaker size is set to [SMALL], the [BASS REDIRECT] setting is fixed to [SUBWOOFER].

#### NOTE

During playback of a DVD AUDIO, audio signal may not be output correctly depending on the conditions of the unit or the disc itself.

## To set the delay time

You can adjust the delay time of each speaker. Selecting each speaker distance, which is on the basis of the distance between the front speakers and the listening position, sets an appropriate delay time. Check that what the distance to each speaker is and set distance values following the procedure.

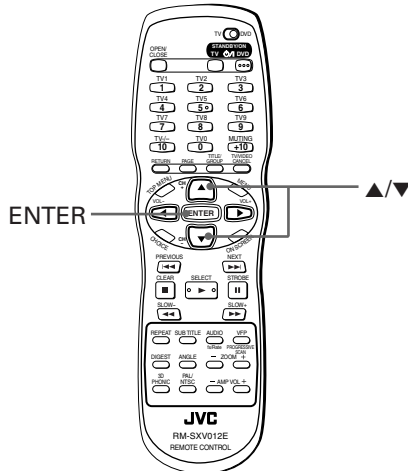

- While the [SPK.SETTING] page of the preference display is shown

- 1 Use ▲/▼ to move to [DELAY] and press ENTER.  
The DELAY display page appears on the TV screen. points to [CENTER SPEAKER]. See page 61 for details about how to bring up the [SPK.SETTING] page.

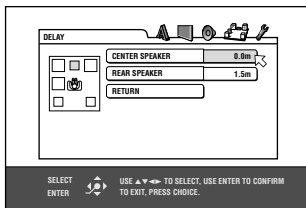

- 2 Use ▲/▼ to select the speaker to be set and press ENTER.  
CENTER SPEAKER: Center speaker  
REAR SPEAKER: Rear speakers
- 3 Use ▲/▼ to select the delay time and press ENTER.  
When you select [CENTER SPEAKER], you can select the delay time from [0.0m] to [1.5m] in 30cm units.  
When you select [REAR SPEAKER], you can select the delay time from [0.0m] to [4.5m] in 30cm units.
- 4 Repeat steps 2 and 3 if you set other speakers.

- To return to the [SPK.SETTING] page  
Use ▲/▼ to move to [RETURN] and press ENTER.

**NOTE**

- For the speaker(s) whose size is set to [NONE], the delay time cannot be set.

## To set the speaker level

You can adjust the output level of each speaker.

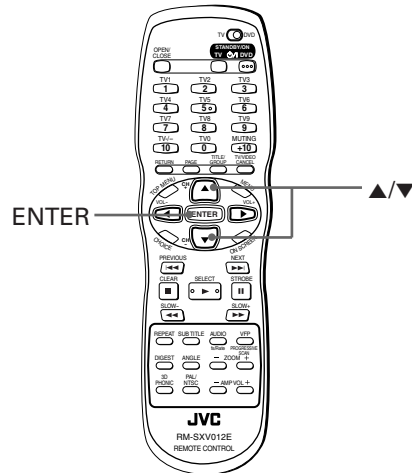

- While the [SPK.SETTING] page of the preference display is shown

- 1 Use ▲/▼ to move to [LEVEL] and press ENTER.  
The LEVEL display page appears on the TV screen. points to [CENTER SPEAKER]. See page 61 for details about how to bring up the [SPK.SETTING] page.

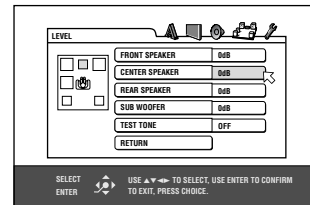

- 2 Use ▲/▼ to select the speaker to be set and press ENTER.  
FRONT SPEAKER: Front speakers (This item cannot be selected. The level is fixed to 0dB.)  
CENTER SPEAKER: Center speaker  
REAR SPEAKER: Rear speakers  
SUB WOOFER: Subwoofer speaker
- 3 Use ▲/▼ to set the level and press ENTER.  
When you select [CENTER SPEAKER], [REAR SPEAKER] or [SUB WOOFER], you can select the level from -6 to 6dB in 1dB units.
- 4 Repeat steps 2 and 3 if you set other speakers.

- To return to the [SPK.SETTING] page  
Use ▲/▼ to move to [RETURN] and press ENTER.

**NOTE**

- For the speaker(s) whose size is set to [NONE], the speaker level cannot be set.

## To generate test tone signals

You can check the level setting by monitoring the test tone.

- 1 Use ▲/▼ to select [TEST TONE] and press ENTER.
- 2 Use ▲/▼ to select [ON] and press ENTER.  
The test tone will be generated when you select the speaker(s) in the [LEVEL] display.

## Limiting playback by children

This function restricts playback of DVD VIDEO discs which contain violent (and other) scenes according to the level set by the user. For example, if a movie which includes violent scenes supports the parental lock feature, such scenes which you do not want to let children view can be cut or replaced with other scenes. When PARENTAL LOCK is set in the OTHERS menu of the Preference display (see page 62), pressing ENTER on the remote control unit brings up the PARENTAL LOCK display shown following. This allows you to set limits on DVD VIDEO playback.

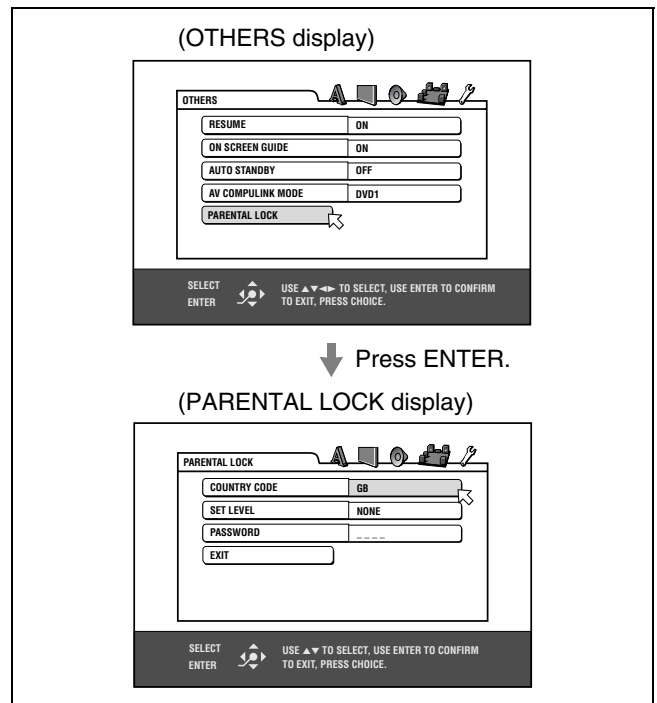

## To set Parental Lock for the first time [PARENTAL LOCK]

Available : 

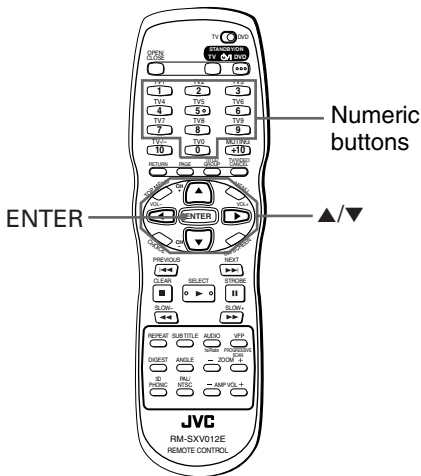

● While the [OTHERS] menu of the preference display is shown

**1** Use ▲/▼ to move  to select [PARENTAL LOCK] and press ENTER.

The Parental Lock on-screen display appears on the TV screen.

 points [COUNTRY CODE].

See page 62 for details about how to bring up the [OTHERS] menu.

**2** While  points to [COUNTRY CODE], press ENTER to bring up the pull-down menu.

**3** Use ▲/▼ to select the country code.

Select the code of the country whose standards were used to rate the DVD VIDEO disc content.

See "Appendix A: Country/Area code list for Parental Lock" on page 75.

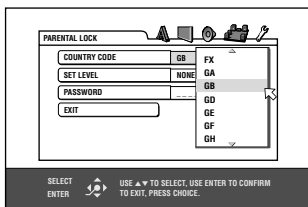

**4** Press ENTER.

 moves to [SET LEVEL].

**5** While  points to [SET LEVEL], press ENTER to bring up the pull-down menu.

In the pull-down menu, [NONE] and levels [8] to [1] are available.

[NONE] does not restrict playback. Level [1] is the strictest level. Discs rated higher than the selected level are restricted.

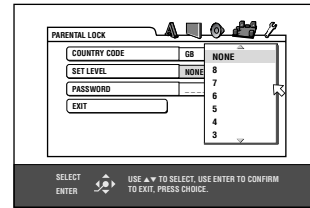

**6** Use ▲/▼ to select a desired parental lock level, then press ENTER.

 moves to [PASSWORD].

**7** Enter a 4-digit password using the numeric buttons (0 to 9).

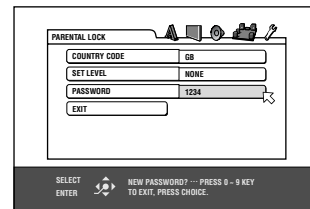

**8** Press ENTER.

The parental lock feature is set.

 moves to [EXIT].

Pressing ENTER again returns to the [OTHERS] menu of the preference display.



- If you want to change the password in step 7, do it before pressing ENTER.

## To change the settings [PARENTAL LOCK]

Available :



You can change the Parental Lock settings later.

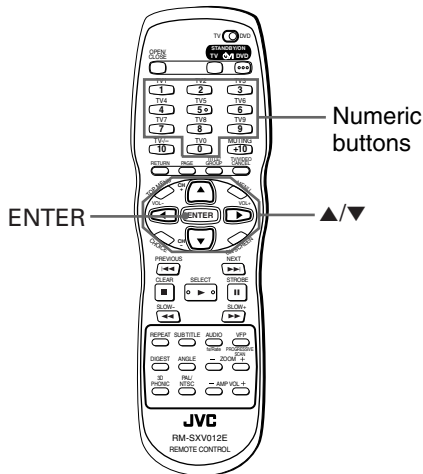

- While the [OTHERS] menu of the preference display is shown

### 1 Use ▲/▼ to move to select [PARENTAL LOCK] and press ENTER.

The Parental Lock on-screen display appears on the TV screen.

points to [PASSWORD].

See page 62 for details about how to bring up the [OTHERS] menu.

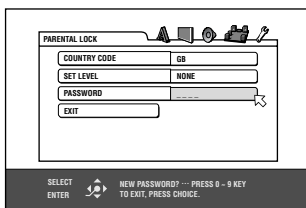

### 2 Enter your current 4-digit password using the numeric buttons (0 to 9) and press ENTER.

moves to [COUNTRY CODE] if you enter the correct password.

If you enter the wrong password, [WRONG! RETRY...] appears on the TV screen, and you cannot go to the next step.

### 3 To change the [COUNTRY CODE] or [LEVEL], press ENTER to bring up the associated pull-down menu when is pointing the desired item.

To select the item to be set, use ▲/▼ when no pull-down menu is shown.

### 4 Use ▲/▼ to select the desired option and press ENTER.

Note that if you change the country code, you must reselect the Parental Lock level.

### 5 With pointing to [PASSWORD], enter a 4-digit password using the numeric buttons (0 to 9).

The password entered in this step becomes the new password. If you want to keep the same password as before, enter the same password you did in step 2. Do not forget to enter a password after changing the country code and/or parental level. Otherwise, the new country code and/or parental level will not take effect.

### 6 Press ENTER.

moves to [EXIT].

Pressing ENTER again returns to the [OTHERS] menu of the preference display.

#### NOTES



- If you enter the wrong password more than 3 times in step 2 above, moves to [EXIT] automatically and ▲/▼ do not work.
- If you forget your password in step 2 Enter "8888". The current password is deleted and you can set a new password.

## To temporarily release the Parental Lock [PARENTAL LOCK]

Available : 

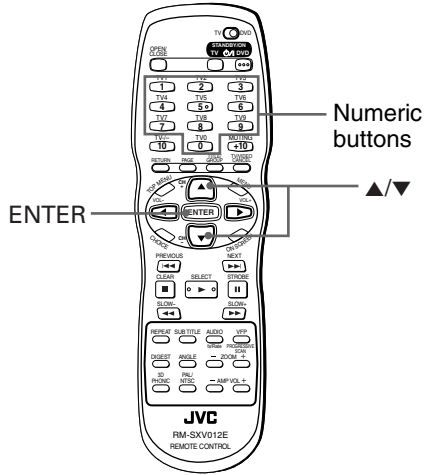
If the parental level is set to a strict value, some discs may not play at all. When you insert such a disc and try to play it, the following Parental Lock on-screen display appears on the TV screen, asking you whether you want the Parental Lock to be temporarily released or not.



- 1 Use the ▲/▼ to move  to [TEMPORARY RELEASE], then press ENTER.  
 moves to [PASSWORD].  
 When selecting [NOT RELEASE], press ▲ (OPEN/CLOSE) to remove the disc.

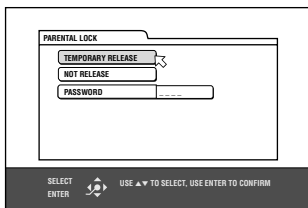

- 2 Enter your 4-digit password using the numeric buttons (0 to 9).  
 The Parental Lock is released, and the unit starts playback.  
 If you enter the wrong password, [WRONG! RETRY...] appears on the TV screen.  
 Enter the correct password.

**NOTE**

- When you enter the wrong password more than 3 times in step 2 above,  moves to [NOT RELEASE] automatically and ▲/▼ do not work.

# Additional information

## Names of parts and controls

Refer to the corresponding pages indicated in ( ) for details.

### Front panel

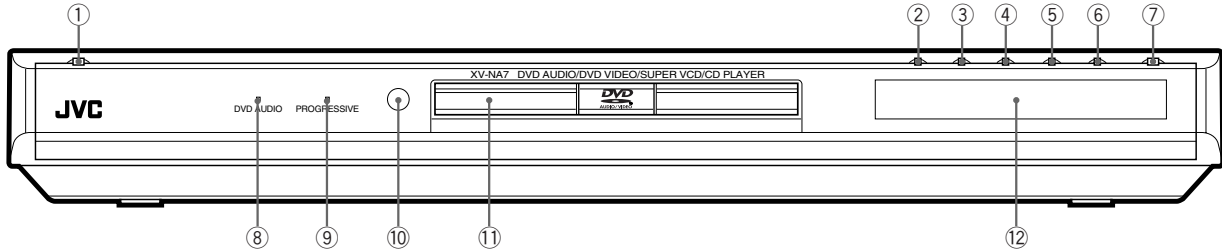

- |                                     |   |
|-------------------------------------|---|
| ① STANDBY/ON $\odot$ /I button (15) | ⑦ ▲ button (18, 20, 21)                       |
| ② ■ button (19, 20, 47)             | ⑧ DVD AUDIO indicator                         |
| ③ ► button (19, 21)                 | ⑨ PROGRESSIVE indicator                       |
| ④    PAUSE button (20, 22)          | ⑩ Remote sensor (13)                          |
| ⑤ ◀◀ button (22, 23)                | ⑪ Disc tray (18, 20)                          |
| ⑥ ▶▶ button (22, 23)                | ⑫ Display window (see the illustration below) |

### Display window

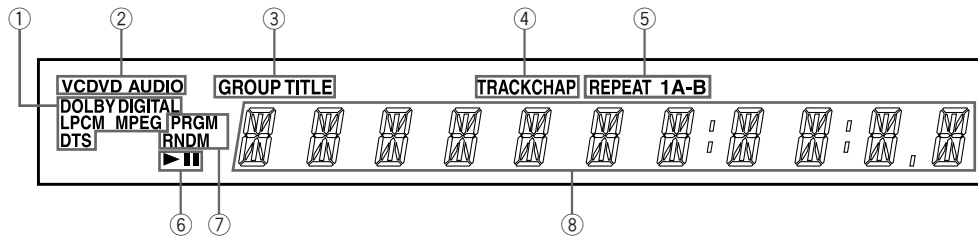

- |                            |                               |
|----------------------------|-------------------------------|
| ① Audio format indicators  | ⑤ Repeat mode indicator       |
| ② Disc indicator           | ⑥ ►(play)/  (pause) indicator |
| ③ Group/title indicators   | ⑦ PROGRAM/RANDOM indicator    |
| ④ Track/chapter indicators | ⑧ Multi-information window    |

### Rear panel

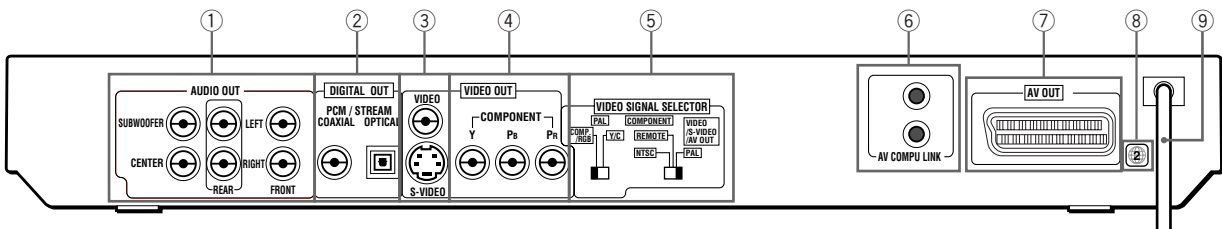

- |   |                         |
|---|-------------------------|
| ① AUDIO OUT jacks (6, 7, 8, 10, 11, 12)     | ⑤ VIDEO SIGNAL SELECTOR |
| ② DIGITAL OUT jacks (OPTICAL/COAXIAL) (12)  | ⑥ AV COMPU LINK jacks   |
| ③ VIDEO OUT - VIDEO jack (6)                | ⑦ AV OUT connector (7)  |
| VIDEO OUT - S-VIDEO jack (7)                | ⑧ Region code label (4) |
| ④ VIDEO OUT - COMPONENT VIDEO OUT jacks (8) | ⑨ AC Power cord (12)    |

## Remote control unit

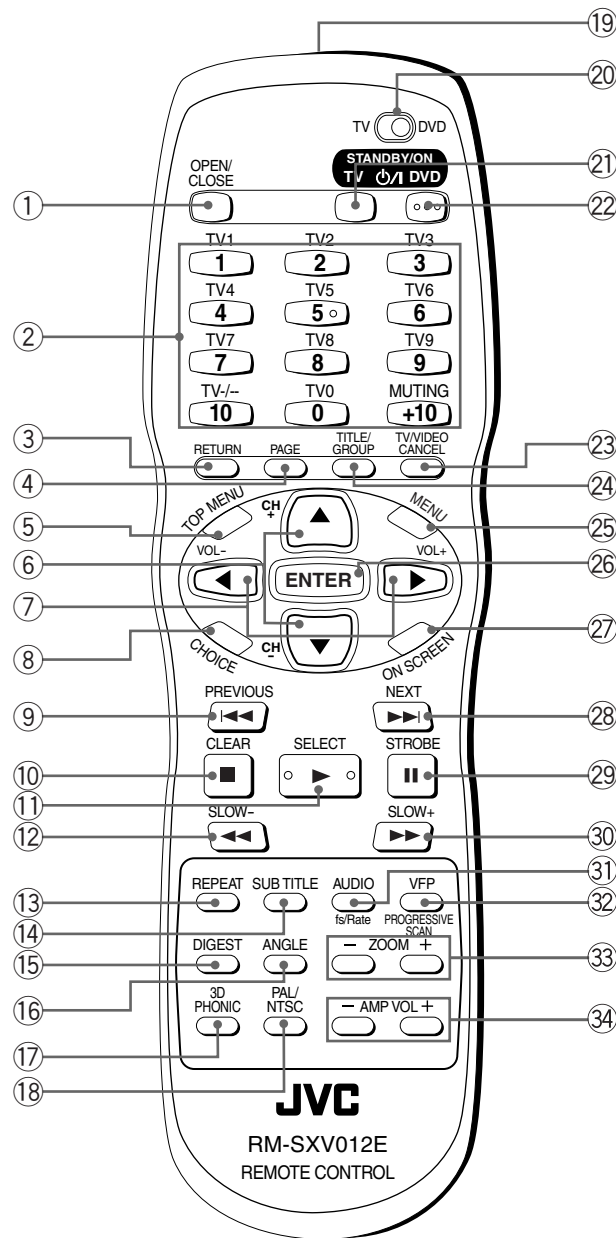

- |  |  |
|--|--|
| <ul style="list-style-type: none"> <li>① OPEN/CLOSE button (18, 20, 21)</li> <li>② Numeric buttons</li> <li>③ RETURN button (27)</li> <li>④ PAGE button (31)</li> <li>⑤ TOP MENU button (27)</li> <li>⑥ Cursor selection (▲ Up, ▼ Down) - CH (+/-) buttons (14)</li> <li>⑦ Cursor selection (◀ Left, ▶ Right) - VOL (+/-) buttons (14)</li> <li>⑧ CHOICE button (16, 57)</li> <li>⑨ ◀◀/PREVIOUS button (22, 23, 47, 52)</li> <li>⑩ ■/CLEAR button (19, 20, 47, 50)</li> <li>⑪ ▶/SELECT button (19, 27, 47, 54)</li> <li>⑫ ◀◀/SLOW- button (22)</li> <li>⑬ REPEAT button (34, 49, 56)</li> <li>⑭ SUBTITLE button (36)</li> <li>⑮ DIGEST button (30)</li> <li>⑯ ANGLE button (25, 38)</li> </ul> | <ul style="list-style-type: none"> <li>⑰ 3D PHONIC button (41)</li> <li>⑱ PAL/NTSC button (9)</li> <li>⑲ Infrared signal window (13)</li> <li>⑳ TV - DVD switch (14, 15, 27, 47, 51, 57)</li> <li>㉑ TV STANDBY/ON ⏻/⏿ button (14)</li> <li>㉒ DVD STANDBY/ON ⏻/⏿ button (15)</li> <li>㉓ TV/VIDEO - CANCEL button (14)</li> <li>㉔ TITLE/GROUP button (28, 49, 55)</li> <li>㉕ MENU button (27)</li> <li>㉖ ENTER button</li> <li>㉗ ON SCREEN button (25, 43)</li> <li>㉘ ▶▶/NEXT button (22, 23, 47, 52)</li> <li>㉙ ⏸/STROBE button (20, 22, 23, 39, 47)</li> <li>㉚ ▶▶/SLOW+ button (22)</li> <li>㉛ AUDIO - fs/Rate button (37, 42, 50)</li> <li>㉜ VFP-PROGRESSIVE SCAN button (10, 40)</li> <li>㉝ ZOOM +/- buttons (40, 53)</li> <li>㉞ AMP VOL +/- buttons (14)</li> </ul> |
|--|--|



## Troubleshooting

What appears to be a malfunction may not always be serious. Please go through the following list before requesting service.

POWER		
Symptom	Possible cause	Remedy
Power does not come on.	Power plug is not inserted securely.	Plug in securely.
OPERATION		
Symptom	Possible cause	Remedy
The remote control unit does not work.	Too far from the unit.	Move closer to the unit.
	The tip of the remote control unit is not pointed in the right direction.	Point the infrared signal window toward the remote sensor on the front panel (see page 13).
	Batteries are exhausted.	Replace the batteries with new ones.
	Battery polarity is incorrect.	Take out the batteries and insert them again in the correct direction.
	The remote control unit is not set for operating your TV.	Set the remote control unit for operating your TV (see page 14).
The PAL/NTSC button on the remote control does not work.	The NTSC/REMOTE/PAL switch is not correctly set.	Set the NTSC/REMOTE/PAL switch on the rear panel to "REMOTE" while the unit is turned off (see page 9).
The TV/VIDEO - CANCEL, ▲/▼/◀/▶ or numeric buttons do not work.	The TV - DVD switch is not correctly set.	To control the unit, set the TV - DVD switch to "DVD". To control your TV, set the TV - DVD switch to "TV" (see page 14).
Operation is not possible.	Microcomputer malfunction due to lightning or static electricity.	Turn off the power and unplug the power cord, then connect the power cord again.
	Moisture condensation caused by a sudden change of temperature or humidity.	Turn off the power, then turn it on a few hours later.
	The disc does not allow the operation, or a non-playable disc is loaded.	Check and replace the disc (see page 4).
The VIDEO SIGNAL SELECTOR on the rear panel cannot be worked.	The switch position changed while unit power is on.	Change the switch position while unit power is off.
When using the TITLE/GROUP button to select a title during DVD VIDEO playback, ⊙ appears on the TV screen and the title cannot be selected.	Disc content does not allow the operation.	Try to press ■ and select a title using the numeric buttons on the remote control.

PICTURE		
Symptom	Possible cause	Remedy
No picture is displayed on the monitor.	Connection of video cable is incorrect.	Connect the cable correctly.
	Input selection of TV is incorrect.	Select correctly.
	Disc is not playable.	Use a playable disc (see page 4).
No picture is displayed on the monitor or the screen is blurred or divided into two parts.	The unit is in the progressive scanning mode (i.e. the PROGRESSIVE indicator is lit) through it is connected to a TV via the VIDEO or S-VIDEO jack.	Make the Progressive scanning mode inactive by using the VFP - PROGRESSIVE SCAN button (see page 10).
The picture is noisy or blurred.	The unit is connected to a VCR directly and the copyguard function is activated.	Connect the unit so that the picture signal flows directly to the TV.
	With some discs, the picture may be blurred when [STILL MODE] is set to [FRAME] or [AUTO].	Set [STILL MODE] to [FIELD] (see page 59).
No picture is displayed when connected to a TV with the VIDEO OUT jack, S-VIDEO jack or SCART connector.	The VIDEO SIGNAL SELECTOR on the rear panel is not set correctly.	Set the VIDEO SIGNAL SELECTOR on the rear panel to "PAL" while the unit is turned off (see page 7).
No picture is displayed when connected to a TV with the COMPONENT VIDEO OUT jacks.		Set the VIDEO SIGNAL SELECTOR on the rear panel to "NTSC" while the unit is turned off (see page 8).
The picture does not fit the television screen.	[MONITOR TYPE] is not set correctly.	Select monitor type correctly (see page 59).
	TV settings are incorrect.	Set the television correctly.
The upper and lower parts of the preference display are cut off when using wide-aspect TV.	It depends on the setting on the TV.	Adjust the TV screen using the controls on the TV.

AUDIO		
Symptom	Possible cause	Remedy
No audio is reproduced.	Connection is incorrect.	Check the connection.
	Input selection of amplifier is incorrect.	Select correctly.
No audio is reproduced when playing back a DVD disc recorded with high sampling frequency (88.2 kHz or more) linear PCM audio using the DIGITAL OUT jack.	Audio signal is not emitted from the unit's DIGITAL OUT (see page 60).	Use AUDIO OUT when playing back such discs.
Audio volume is low when playing back with the unit, compared with the TV or VCR.	The audio level recorded on a DVD VIDEO is lower compared with a TV broadcast.	Turn up the volume of the TV or amplifier/receiver. Remember to turn the volume back down before switching back to a TV broadcast to prevent a sudden burst of high-volume sound.
Sound is distorted or noise is generated.	Disc is dirty.	Wipe the disc surface (see page 5).
[MULTI CH] is shown in the display window when playing back DVD AUDIO disc.	The track is prohibited from down-mixing to 2-channel stereo audio.	Listen in multichannel surround audio.

## Frequently Asked Questions

Question	Answer	Ref. page
Can I play back DVD VIDEO and Video CD discs purchased abroad?	You can play DVD VIDEO disc with the Region Code (local code) containing "ALL" or "2" recorded using the NTSC or PAL formats. You can select "NTSC" or "PAL" while using the NTSC/REMOTE/PAL switch on the rear panel.	4
Can I play back a DVD VIDEO disc without any Region Code number?	The Region code indicates conformity to DVD standards. Any DVD VIDEO which does not conform to the DVD standards cannot be played.	4
Can I play back a CD-R/RW disc with still pictures in other than the JPEG format?	No, the unit cannot display pictures in formats other than JPEG.	4
Can I play back audio on a disc labeled "Dolby Digital EX"?	Yes, you can play back the disc because Dolby Digital EX is compatible with Dolby Digital. However, to get the maximum performance of Dolby Digital EX, we recommend to connect the DIGITAL OUT jack to a decoder or amplifier/receiver with built-in decoder that supports Dolby Digital EX. In this case, set [DIGITAL AUDIO OUTPUT] on the [AUDIO] preference display to [STREAM/PCM].	60
Can I play back audio on a disc labeled "DTS ES"? Is there any difference in the playback settings between Discrete and Matrix recording systems for DTS ES?	You cannot listen to the audio using the analog audio outputs (AUDIO OUT). However, you can listen to DTS ES audio by connecting the DIGITAL OUT jack to a decoder or amplifier/receiver with built-in decoder that supports DTS ES. In this case, set [DIGITAL AUDIO OUTPUT] on the [AUDIO] preference display to [STREAM/PCM].	60
Can this unit play back a disc labeled "THX"? What does "THX" mean?	Yes you can. "THX" is the name of a standard for high quality picture and audio recording, established by Lucasfilm Ltd. The "THX" label on a disc certifies that it meets this standard.	—
When files of the MP3 and Audio CD formats are recorded on a same disc, can the unit play files of both formats?	Discs like this are of the data CD format, not the Audio CD format. The unit can play only the MP3 files.	4, 47
Some Dolby Digital discs contain 5.1-ch Surround or Dolby Surround audio data. What is the difference between these two types?	Both are surround sound standards developed by Dolby Laboratories Inc. in the U.S.A. In Dolby Surround, two-channel surround audio information is recorded onto the analog stereo (left and right) channels together with front stereo audio information. When played back, the surround signals are separated by a Dolby Surround or Dolby Pro Logic decoder. Dolby Digital digitally encodes and records up to six channels of information for left, right, center, rear left, rear right and LFE (Low-Frequency Effect, for use with a subwoofer). When played back, a Dolby Digital decoder decodes the data and outputs signals separately. Generally, Dolby Digital sounds better.	4
When playing back a DVD VIDEO or Video CD disc, something like a mosaic appears on the TV screen. Is this because of a malfunction of the unit?	This is block noise specific to a digitally recorded motion picture. It is not a malfunction of the unit.	—
The unit does not function as described in this Instruction Manual.	The operation of this unit may occasionally be unacceptable due to the intention of the disc contents creator and/or structural restrictions.	—
Can I record DVD VIDEO data on a video tape?	Most of all DVD VIDEO discs are copy-protected so that you cannot record DVD VIDEO data onto any video tape.	3
Can this unit record data?	No, it cannot.	—

# Specifications

\* Specifications and appearance subject to change without prior notice.

## General

Readable discs: DVD AUDIO, DVD VIDEO, DVD-R (Video format), SVCD, Video CD, Audio CD (CD-DA), MP3 format, JPEG, CD-R/RW (CD-DA, SVCD, Video CD, MP3 format, JPEG)  
 Video format: PAL: 625i (Interlaced scanning)  
 NTSC: 525i (Interlaced scanning)/525p (Progressive scanning) (selectable)

## Other

Power requirements: AC 230 V  $\sim$ , 50 Hz  
 Power consumption: 15 W (POWER ON), 2.4 W (STANDBY mode)  
 Mass: 2.4 kg  
 Dimensions (W  $\times$  H  $\times$  D): 435 mm  $\times$  55 mm  $\times$  258.4 mm

## Video outputs

COMPONENT (pin jacks): Y Output: 1.0 Vp-p (75  $\Omega$ )  
 P<sub>B</sub>/P<sub>R</sub> Output: 0.7 Vp-p (75  $\Omega$ )  
 VIDEO OUT (pin jack): 1.0 Vp-p (75  $\Omega$ )  
 S-VIDEO OUT (S jack): Y Output: 1.0 Vp-p (75  $\Omega$ )  
 C Output: 286 mVp-p (75  $\Omega$ )  
 RGB Output: 700mVp-p(75  $\Omega$ )  
 Horizontal resolution: 500 Lines or more

## Audio outputs

ANALOG OUT (pin jack): 2.0 Vrms (10 k $\Omega$ )  
 DIGITAL OUT: (COAXIAL): 0.5 Vp-p (75  $\Omega$  termination)  
 (OPTICAL): -21 dBm to -15 dBm (peak)

## Audio characteristics

Frequency response: CD (sampling frequency 44.1 kHz): 2 Hz to 20 kHz  
 DVD (sampling frequency 48 kHz): 2 Hz to 22 kHz  
 (2 Hz to 20 kHz for DTS and Dolby Digital bitstream signals)  
 DVD (sampling frequency 96kHz/88.2 kHz): 2 Hz to 44 kHz  
 DVD (sampling frequency 192 kHz/176.4 kHz): 2 Hz to 88 kHz  
 Dynamic range: 16 bit: More than 98 dB  
 20 bit: More than 110 dB  
 24 bit: More than 110 dB  
 Wow and flutter: Unmeasurable (less than  $\pm$  0.002%)  
 Total harmonic distortion: Less than 0.002%

## Appendix A: Country/Area code list for Parental Lock

This list is used for the Parental Lock operation. For details, see page 65.

AD	Andorra
AE	United Arab Emirates
AF	Afghanistan
AG	Antigua and Barbuda
AI	Anguilla
AL	Albania
AM	Armenia
AN	Netherlands Antilles
AO	Angola
AQ	Antarctica
AR	Argentina
AS	American Samoa
AT	Austria
AU	Australia
AW	Aruba
AZ	Azerbaijan
BA	Bosnia and Herzegovina
BB	Barbados
BD	Bangladesh
BE	Belgium
BF	Burkina Faso
BG	Bulgaria
BH	Bahrain
BI	Burundi
BJ	Benin
BM	Bermuda
BN	Brunei Darussalam
BO	Bolivia
BR	Brazil
BS	Bahamas
BT	Bhutan
BV	Bouvet Island
BW	Botswana
BY	Belarus
BZ	Belize
CA	Canada
CC	Cocos (Keeling) Islands
CF	Central African Republic
CG	Congo
CH	Switzerland
CI	Côte d'Ivoire
CK	Cook Islands
CL	Chile
CM	Cameroon
CN	China
CO	Colombia
CR	Costa Rica
CU	Cuba
CV	Cape Verde
CX	Christmas Island
CY	Cyprus
CZ	Czech Republic
DE	Germany
DJ	Djibouti
DK	Denmark
DM	Dominica
DO	Dominican Republic
DZ	Algeria
EC	Ecuador
EE	Estonia
EG	Egypt
EH	Western Sahara
ER	Eritrea
ES	Spain
ET	Ethiopia
FI	Finland
FJ	Fiji
FK	Falkland Islands (Malvinas)
FM	Micronesia (Federated States of)
FO	Faroe Islands
FR	France
FX	France, Metropolitan
GA	Gabon
GB	United Kingdom
GD	Grenada
GE	Georgia
GF	French Guiana
GH	Ghana
GI	Gibraltar
GL	Greenland
GM	Gambia
GN	Guinea
GP	Guadeloupe
GQ	Equatorial Guinea
GR	Greece
GS	South Georgia and the South Sandwich Islands
GT	Guatemala
GU	Guam
GW	Guinea-Bissau
GY	Guyana
HK	Hong Kong
HM	Heard Island and McDonald Islands
HN	Honduras
HR	Croatia
HT	Haiti
HU	Hungary
ID	Indonesia
IE	Ireland
IL	Israel
IN	India
IO	British Indian Ocean Territory
IQ	Iraq
IR	Iran (Islamic Republic of)
IS	Iceland
IT	Italy
JM	Jamaica
JO	Jordan
JP	Japan
KE	Kenya
KG	Kyrgyzstan
KH	Cambodia
KI	Kiribati
KM	Comoros
KN	Saint Kitts and Nevis
KP	Korea, Democratic People's Republic of
KR	Korea, Republic of
KW	Kuwait
KY	Cayman Islands
KZ	Kazakhstan
LA	Lao People's Democratic Republic
LB	Lebanon
LC	Saint Lucia
LI	Liechtenstein
LK	Sri Lanka
LR	Liberia
LS	Lesotho
LT	Lithuania
LU	Luxembourg
LV	Latvia
LY	Libyan Arab Jamahiriya
MA	Morocco
MC	Monaco
MD	Moldova, Republic of
MG	Madagascar
MH	Marshall Islands
ML	Mali
MM	Myanmar
MN	Mongolia
MO	Macau
MP	Northern Mariana Islands
MQ	Martinique
MR	Mauritania
MS	Montserrat
MT	Malta
MU	Mauritius
MV	Maldives
MW	Malawi
MX	Mexico
MY	Malaysia
MZ	Mozambique
NA	Namibia
NC	New Caledonia
NE	Niger
NF	Norfolk Island
NG	Nigeria
NI	Nicaragua
NL	Netherlands
NO	Norway
NP	Nepal
NR	Nauru
NU	Niue
NZ	New Zealand
OM	Oman
PA	Panama
PE	Peru
PF	French Polynesia
PG	Papua New Guinea
PH	Philippines
PK	Pakistan
PL	Poland
PM	Saint Pierre and Miquelon
PN	Pitcairn
PR	Puerto Rico
PT	Portugal
PW	Palau
PY	Paraguay
QA	Qatar
RE	Réunion
RO	Romania
RU	Russian Federation
RW	Rwanda
SA	Saudi Arabia
SB	Solomon Islands
SC	Seychelles
SD	Sudan
SE	Sweden
SG	Singapore
SH	Saint Helena
SI	Slovenia
SJ	Svalbard and Jan Mayen
SK	Slovakia
SL	Sierra Leone
SM	San Marino
SN	Senegal
SO	Somalia
SR	Suriname
ST	Sao Tome and Principe
SV	El Salvador
SY	Syrian Arab Republic
SZ	Swaziland
TC	Turks and Caicos Islands
TD	Chad
TF	French Southern Territories
TG	Togo
TH	Thailand
TJ	Tajikistan
TK	Tokelau
TM	Turkmenistan
TN	Tunisia
TO	Tonga
TP	East Timor
TR	Turkey
TT	Trinidad and Tobago
TV	Tuvalu
TW	Taiwan
TZ	Tanzania, United Republic of
UA	Ukraine
UG	Uganda
UM	United States Minor Outlying Islands
US	United States
UY	Uruguay
UZ	Uzbekistan
VA	Vatican City State (Holy See)
VC	Saint Vincent and the Grenadines
VE	Venezuela
VG	Virgin Islands (British)
VI	Virgin Islands (U.S.)
VN	Vietnam
VU	Vanuatu
WF	Wallis and Futuna Islands
WS	Samoa
YE	Yemen
YT	Mayotte
YU	Yugoslavia
ZA	South Africa
ZM	Zambia
ZR	Zaire
ZW	Zimbabwe

## Appendix B: Glossary

### Aspect ratio

A ratio which defines the shape of the rectangular picture in a TV. It is the width of the picture relative to the height. A conventional TV picture is 4:3 in aspect ratio.

### Bitstream

The digital form of multichannel audio data (e.g., 5.1-channel) before it is decoded into its various channels.

### Channel, CH

Stereo or multichannel audio consists of "channel" signals. "Stereo" audio consists of left and right channels, while 5.1-channel Dolby Digital consists of six channels (front left, front right, rear left, rear right, center and LFE (Low-Frequency Effect channel), for use with a sub-woofer).

### Chapter

The smallest division on DVD VIDEO. It is a division of a title and similar to a track for Audio CD or Video CD.

### Component video

Video signals with three channels of separate information that makes up the picture. There are some types of component video, such as R/G/B and Y/C<sub>B</sub>(P<sub>R</sub>)/C<sub>R</sub>(P<sub>R</sub>).

### Composite video

A single video signal commonly used in most consumer video products that contains all luminance, color, and synchronization information.

### Dolby Digital (AC3)

A six-channel system consisting of left, center, right, left rear, right rear and LFE (Low-Frequency Effect channel, for use with a sub-woofer) channels. All processing is done in the digital domain. Not all Dolby Digital discs contain six (5.1) channels of information.

### Dolby Surround/Dolby Pro Logic/Dolby Pro Logic II

Dolby Surround is a five-channel system consisting of left, center, right and left rear, right rear channels. All processing is done in the digital domain. Dolby Pro Logic is a four-channel system consisting of left, center, right and rear channels. The single rear channel is usually played through two speakers. Dolby Pro Logic II is an advanced matrix decoder that derives five-channel surround (Left, Center, Right, Left Surround, and Right Surround) from any stereo program material, whether or not it has been specifically Dolby Surround encoded.

### Down - mix

Internal stereo mix of multichannel surround audio by a DVD player. The down - mix signals are output from stereo output connectors.

### DTS

A Digital Surround audio encoding format configured with six (5.1) channels, similar to Dolby Digital. It requires a decoder, either in the player or in an external receiver. DTS stands for Digital Theater Systems. Not all DTS discs contain six (5.1) channels of information.

### Dynamic range

The difference between the loudest and softest sounds.

### Dynamic range compression

The dynamic range compression (DRC) reduces the dynamic range so that you can turn down the volume to avoid disturbing others yet still hear the detail of quiet passages.

### Extension

Several letters at the end of a file name. File name extensions usually follow a period and indicate the type of information stored in the file.

### Finalize

When conducting multisession recording, this means the closing of a session (fixing) by indicating the halting of writing so as to prevent the addition of any more sessions.

### F<sub>s</sub>

See "Sampling frequency."

### Group

The largest division on DVD AUDIO.

### ID3 tag

A tag embedded in an MP3 file indicating what song, artist, and album it comes from. You can edit these tags.

### Interlaced scanning

In a conventional video system, a picture is shown on the display monitor in between lines of two halves. The Interlaced scanning system places lines of the second half of the picture in-between lines of the first half of the picture.

### ISO 9660 Format

The most common international standard for the logical format of files and directories on a CD-ROM.

### JPEG

A popular file format for still image compression and storage.

JPEG stands for Joint Photographic Experts Group. There are three sub-types of the JPEG format as follows.

- baseline JPEG: used for digital cameras, the web, etc.
- progressive JPEG: used for the web
- lossless JPEG: an old type, rarely used now

### Letter box

A type of video display for normal (4:3) TV screens. Black bars are shown at the top and bottom of the image to allow playing of a wide-screen (16:9) movie without cutting off any of the image.

### Linear PCM audio

PCM stands for "pulse code modulation." Linear PCM is the usual method for digitally encoding audio without compression, and is used for the audio tracks on DVD VIDEO discs, Audio CDs, etc.

### Menu

Most DVD AUDIO, DVD VIDEO or SVCD/Video CD discs provide a menu, through which users can select desired material, conditions, etc.

**MLP**

MLP stands for "Meridian Lossless Packing." A lossless audio compression system that can completely recreate the PCM signal.

**MP3**

MP3 is an audio data compression format, which stands for MPEG-1 Audio Layer 3. Using MP3, you can achieve a data reduction of about 1:10.

**MPEG**

A family of Standards for compressing audio-visual information. "MPEG" standards include MPEG-1, MPEG-2 and MPEG-4. Video CD and MP3 are based on MPEG-1, while DVD is based on MPEG-2. MPEG stands for Moving Picture coding Experts Group.

**MPEG Multichannel**

This feature expands the 5.1 channel audio format recorded on the disc to a 7.1 channel format. The further expansion of the 5.1 channel audio makes it easy for you to reproduce the movie theater experience in your own home.

**Multisession**

A method of adding data to a CD-R/CD-RW in more than one recording session using the Track-At-Once method.

**NTSC (National television system committee)**

A black and white and color television system format used in the U.S.A., Canada, Mexico and Japan.

**Packet Writing**

A method of writing data on a CD-R/CD-RW in small increments. Packets can be of fixed or variable length.

**PAL (Phase Alternation by Line)**

A color television system format used extensively in Western Europe.

**Pan and scan**

A type of video display for normal (4:3) TV screens. The image is zoomed to fill the screen vertically, and the field of view may be panned while the left and/or right sides of the picture are cut off.

**Parental lock**

A DVD function that prevents undesired viewing by children depending on disc content. Ordinarily, a password is required to play back a locked disc. Otherwise, undesirable scenes are automatically skipped or replaced with other pictures.

**PBC**

PBC stands for "Playback control" and is a method of controlling disc play for Video CDs (VCD). You are able to interact with the disc through menus.

**Region code**

Code identifying a geographic region of compatibility for a DVD.

**RGB**

An abbreviation for Red, Green, and Blue. Color monitors and color television sets display different hues by mixing these three colors.

**Sampling frequency**

The rate at which measurements of an audio signal are taken during A/D and D/A conversion. The sampling frequency is expressed in samples per second.

**Surround**

An audio system with more than two (left and right) channels, usually including rear channels, etc.

**S-video**

A video signal which improves picture quality over standard composite connections. Used on Super VHS, DVD, high end TV monitors, etc.

**Title**

The largest division on DVD VIDEO.

**Track**

The smallest division on SVCD, Video CD and Audio CD discs.

**Transfer rate**

The rate of transferring digital data. The transfer rate is usually expressed in bits per second. The DVD system uses a variable transfer rate for high efficiency.



## **SAFETY INSTRUCTIONS**

### **“SOME DOS AND DON'TS ON THE SAFE USE OF EQUIPMENT”**

This equipment has been designed and manufactured to meet international safety standards but, like any electrical equipment, care must be taken if you are to obtain the best results and safety is to be assured.

Do read the operating instructions before you attempt to use the equipment.

Do ensure that all electrical connections (including the mains plug, extension leads and interconnections between pieces of equipment) are properly made and in accordance with the manufacturer's instructions. Switch off and withdraw the mains plug when making or changing connections.

Do consult your dealer if you are ever in doubt about the installation, operation or safety of your equipment.

Do be careful with glass panels or doors on equipment.

DON'T continue to operate the equipment if you are in any doubt about it working normally, or if it is damaged in any way—switch off, withdraw the mains plug and consult your dealer.

DON'T remove any fixed cover as this may expose dangerous voltages.

DON'T leave equipment switched on when it is unattended unless it is specifically stated that it is designed for unattended operation or has a standby mode.

Switch off using the switch on the equipment and make sure that your family know how to do this.

Special arrangements may need to be made for infirm or handicapped people.

DON'T use equipment such as personal stereos or radios so that you are distracted from the requirements of traffic safety. It is illegal to watch television whilst driving.

DON'T listen to headphones at high volume as such use can permanently damage your hearing.

DON'T obstruct the ventilation of the equipment, for example with curtains or soft furnishings.

Overheating will cause damage and shorten the life of the equipment.

DON'T use makeshift stands and NEVER fix legs with wood screws — to ensure complete safety always fit the manufacturer's approved stand or legs with the fixings provided according to the instructions.

DON'T allow electrical equipment to be exposed to rain or moisture.

ABOVE ALL

- NEVER let anyone, especially children, push anything into holes, slots or any other opening in the case -this could result in a fatal electrical shock.;
- NEVER guess or take chances with electrical equipment of any kind -it is better to be safe than sorry!

  
**JVC**  
VICTOR COMPANY OF JAPAN, LIMITED



## ENGLISH

### Caution!

Before connecting the unit to other equipment, be sure to set the VIDEO SIGNAL SELECTOR switches on the unit's rear panel properly for the type of connection you are making. Be sure to set the switch while the unit power is off. The table below describes the proper settings. If the VIDEO SIGNAL SELECTOR switches are not set properly, the unit will not be able to display video correctly.

Always shut off power to the unit if you change the setting after making connections. See the unit's Instructions manual for more information.

VIDEO SIGNAL SELECTOR Jacks	NTSC/REMOTE/ PAL switch	COMP./RGB - Y/C switch
AV OUT (SCART) *1	PAL	COMP./RGB or Y/C
VIDEO *1	PAL	COMP./RGB
S-VIDEO *1	PAL	Y/C
COMPONENT VIDEO OUT *2	NTSC or REMOTE	COMP./RGB or Y/C (Don't care)

\*1: When connecting the DVD player using the VIDEO, S-VIDEO jack, or AV OUT (SCART) connectors, you must set the NTSC/REMOTE/PAL switch to "PAL."

\*2: Signals in NTSC format are output only from the COMPONENT VIDEO OUT jacks.

## DEUTSCH

### Vorsicht!

Bevor Sie das Gerät an andere Geräte anschließen, müssen Sie unbedingt den VIDEO SIGNAL SELECTOR Schalter auf der Rückseite des Geräts auf den neuen Anschlußtyp stellen. Stellen Sie den Schalter unbedingt nur bei ausgeschaltetem Gerät um. Die korrekten Einstellungen sind auf der nachstehenden Tabelle aufgeführt. Falls der VIDEO SIGNAL SELECTOR Schalter nicht korrekt gestellt ist, kann das Gerät kein richtiges Videobild anzeigen.

Schalten Sie grundsätzlich die Steckverbindung zum Gerät aus, falls Sie die Einstellung nach Anschluß der Kabel ändern wollen. Näheres hierzu finden Sie in der Bedienungsanleitung des Geräts.

VIDEO SIGNAL SELECTOR Buchsen	NTSC/REMOTE/ PAL Schalter	COMP./RGB-Y/C- Schalter
AV OUT (SCART) *1	PAL	COMP./RGB oder Y/C
VIDEO *1	PAL	COMP./RGB
S-VIDEO *1	PAL	Y/C
COMPONENT VIDEO OUT *2	NTSC oder REMOTE	COMP./RGB oder Y/C (gleichgültig)

\*1: Wenn Sie den DVD-Player über die Buchsen VIDEO, S-VIDEO oder AV OUT (SCART) anschließen, müssen Sie den NTSC/REMOTE/PAL-Schalter auf "PAL" stellen.

\*2: Ein Signal im NTSC-Format wird nur von den COMPONENT VIDEO OUT Buchsen ausgespeist.

## FRANÇAIS

### Attention!

Avant de raccorder l'appareil à un autre équipement, régler correctement les sélecteurs VIDEO SIGNAL SELECTOR sur le panneau arrière de l'appareil pour le type de raccordement à faire. Régler les sélecteurs quand l'appareil est hors tension. Le tableau ci-dessous indique les réglages corrects. Si les sélecteurs sélecteurs VIDEO SIGNAL SELECTOR ne sont pas réglés correctement, l'appareil ne pourra pas afficher correctement la vidéo.

Toujours mettre l'appareil hors tension si le réglage est modifié après les connexions. Voir le mode d'emploi de l'appareil pour plus d'informations.

VIDEO SIGNAL SELECTOR Prises	Commutateur NTSC/REMOTE/ PAL	Commutateur COMP/RGB - Y/C
AV OUT (SCART) *1	PAL	COMP/RGB ou Y/C
VIDEO *1	PAL	COMP./RGB
S-VIDEO *1	PAL	Y/C
COMPONENT VIDEO OUT *2	NTSC ou REMOTE	COMP/RGB ou Y/C (l'un ou l'autre)

\*1: A la connexion du lecteur DVD en utilisant les connecteurs VIDEO, S-VIDEO ou AV OUT (SCART), le commutateur NTSC/REMOTE/PAL doit être réglé à "PAL".

\*2: Les signaux en format NTSC sont fournis seulement des prises COMPONENT VIDEO OUT.

## NEDERLANDS

### Let op!

Voordat u het apparaat op andere apparatuur aansluit, moet u de VIDEO SIGNAL SELECTOR schakelaars op het achterpaneel correct instellen overeenkomstig het soort aansluiting dat u maakt. Verzet de schakelaars terwijl het apparaat is uitgeschakeld. De onderstaande tabel toont de voorgeschreven instellingen. Als de VIDEO SIGNAL SELECTOR schakelaars niet correct zijn ingesteld, zal het beeld niet juist worden weergegeven.

Schakel het apparaat altijd uit als u de instellingen wijzigt nadat de aansluitingen zijn gemaakt. Zie de Gebruiksaanwijzing van het apparaat voor nadere bijzonderheden.

VIDEO SIGNAL SELECTOR Aansluitingen	NTSC/REMOTE/ PAL schakelaar	COMP./RGB - Y/C schakelaar
AV OUT (SCART) *1	PAL	COMP./RGB of Y/C
VIDEO *1	PAL	COMP./RGB
S-VIDEO *1	PAL	Y/C
COMPONENT VIDEO OUT *2	NTSC of REMOTE	COMP./RGB of Y/C (Niet van belang)

\*1: Wanneer u de DVD-speler via de VIDEO, S-VIDEO of AV OUT (SCART) aansluitingen aansluit, moet u de NTSC/REMOTE/PAL schakelaar op "PAL" zetten.

\*2: Signalen in NTSC formaat kunnen alleen via de COMPONENT VIDEO OUT aansluitingen worden uitgestuurd.

## ESPAÑOL

### ¡Precaución!

Antes de conectar la unidad a otro equipo, asegúrese de ajustar correctamente los selectores VIDEO SIGNAL del panel posterior de la unidad de acuerdo con el tipo de conexión realizada. Asegúrese de ajustar el selector mientras la alimentación de la unidad esté desconectada. La tabla siguiente describe los ajustes apropiados. Si no se ajustan correctamente los selectores VIDEO SIGNAL, la unidad no podrá mostrar correctamente el vídeo.

Desconecte siempre la alimentación de la unidad para cambiar el ajuste después de haber hecho las conexiones. Para más información, consulte el manual de instrucciones de la unidad.

VIDEO SIGNAL SELECTOR Tomas	Selector NTSC/ REMOTE/PAL	Selector COMP./ RGB - Y/C
AV OUT (SCART) *1	PAL	COMP./RGB o Y/C
VIDEO *1	PAL	COMP./RGB
S-VIDEO *1	PAL	Y/C
COMPONENT VIDEO OUT *2	NTSC o REMOTE	COMP./RGB o Y/C (Cualquiera)

\*1: Cuando conecte el reproductor de DVD empleando los conectores VIDEO, S-VIDEO o AV OUT (SCART), deberá ajustar el selector NTSC/REMOTE/PAL en "PAL".

\*2: Las señales en el formato NTSC sólo se emiten por las tomas COMPONENT VIDEO OUT.

## ITALIANO

### Attenzione!

Prima di collegare l'apparecchio ad un altro apparecchio, accertarsi di regolare gli interruttori VIDEO SIGNAL SELECTOR sul pannello posteriore dell'apparecchio appropriatamente al tipo di collegamento che si sta eseguendo. Accertarsi di regolare l'interruttore mentre l'apparecchio è spento. La tabella sottostante descrive le impostazioni appropriate. Se gli interruttori VIDEO SIGNAL SELECTOR non sono regolati appropriatamente, l'apparecchio non sarà in grado di visualizzare le immagini correttamente.

Spegnerne sempre l'apparecchio se si cambia l'impostazione dopo aver eseguito i collegamenti. Per ulteriori informazioni, consultare il manuale delle istruzioni per l'uso ("Istruzioni") dell'apparecchio.

VIDEO SIGNAL SELECTOR Prese	Interruttore NTSC/REMOTE/ PAL	Interruttore COMP./ RGB - Y/C
AV OUT (SCART) *1	PAL	COMP./RGB o Y/C
VIDEO *1	PAL	COMP./RGB
S-VIDEO *1	PAL	Y/C
COMPONENT VIDEO OUT *2	NTSC o REMOTE	COMP./RGB o Y/C (Indifferentemente)

\*1: Quando si collega il lettore DVD usando i connettori VIDEO, S-VIDEO o AV OUT (SCART), si deve regolare l'interruttore NTSC/REMOTE/PAL su "PAL".

\*2: I segnali nel formato NTSC vengono emessi soltanto dalle prese COMPONENT VIDEO OUT.

## SVENSKA

### Observera!

Innan du ansluter apparaten till någon annan utrustning, måste du komma ihåg att ställa in omkopplarna VIDEO SIGNAL SELECTOR på baksidan av denna apparat för den typ av anslutning du tänker utföra. Var noga med att ställa in omkopplarna medan apparaten är avstängd. Tabellen här nedan beskriver de korrekta inställningarna. Om omkopplarna VIDEO SIGNAL SELECTOR inte ställs in korrekt, kan apparaten inte visa bilder på ett riktigt sätt.

Stäng alltid av apparaten, om du ändrar en inställning efter anslutningen. Se apparatens bruksanvisning för ytterligare upplysningar.

VIDEO SIGNAL SELECTOR Utgångar	Omkopplaren NTSC/REMOTE/ PAL	Omkopplaren COMP./RGB - Y/C
AV OUT (SCART) *1	PAL	COMP./RGB eller Y/C
VIDEO *1	PAL	COMP./RGB
S-VIDEO *1	PAL	Y/C
COMPONENT VIDEO OUT *2	NTSC eller REMOTE	COMP./RGB eller Y/C (Har ingen betydelse.)

\*1: När du ansluter DVD-spelaren med användning av utgången VIDEO, S-VIDEO eller AV OUT (SCART), måste du sätta omkopplaren NTSC/REMOTE/PAL i läge "PAL".

\*2: Signaler i NTSC-formatet matas endast ut från utgången COMPONENT VIDEO OUT.

## SUOMI

### Huomautus

Ennen kuin liität laitteen muuhun laitteeseen, aseta laitteen takaseinässä olevat VIDEO SIGNAL SELECTOR -kytkimet sopiviksi tekemällesi liitäntätyyppille. Säädä kytkimen asento laitteen virran ollessa katkaistu. Oikeat säädöt on näytetty alla olevassa taulukossa. Jos VIDEO SIGNAL SELECTOR -kytkimiä ei aseteta oikein, laite ei pysty näyttämään videota oikealla tavalla.

Katkaise aina virta laitteesta, jos muutat säätöä liitäntöjen suorittamisen jälkeen. Katso tarkemmat tiedot laitteen käyttöohjeesta.

VIDEO SIGNAL SELECTOR Liittimet	NTSC/REMOTE/ PAL -kytkin	COMP./RGB - Y/C - kytkin
AV OUT (SCART) *1	PAL	COMP./RGB tai Y/C
VIDEO *1	PAL	COMP./RGB
S-VIDEO *1	PAL	Y/C
COMPONENT VIDEO OUT *2	NTSC tai REMOTE	COMP./RGB tai Y/C (Älä välitä)

\*1: Kun DVD-soitin liitetään käyttämällä VIDEO, S-VIDEO, tai AV OUT (SCART) liittimiä, NTSC/REMOTE/PAL -kytkin on asetettava asentoon "PAL".

\*2: NTSC-formaatin signaalit lähtevät vain liittimistä COMPONENT VIDEO OUT.

## DANSK

### Forsigtig!

Inden du tilslutter apparatet til andet udstyr, skal du huske at sætte VIDEO SIGNAL SELECTOR-omskifterne på apparatets bagside i den stilling, der modsvarer den type tilslutning, du udfører. Husk at sætte omskifteren i stilling, mens der er slukket for apparatet. I nedenstående oversigt beskrives de rigtige indstillinger. Hvis VIDEO SIGNAL SELECTOR-omskifterne ikke er sat i den rigtige stilling, kan apparatet ikke vise videoen på korrekt vis.

Sluk altid for apparatet, hvis du ændrer indstillingen, efter at du har foretaget tilslutningerne. Vi henviser til brugsvejledningen for apparaterne angående yderligere oplysninger.

VIDEO SIGNAL SELECTOR Jackstik	NTSC/REMOTE/ PAL-omkifter	COMP./RGB- omkifter
AV OUT (SCART) *1	PAL	COMP./RGB eller Y/C
VIDEO *1	PAL	COMP./RGB
S-VIDEO *1	PAL	Y/C
COMPONENT VIDEO OUT *2	N NTSC eller REMOTE	COMP./RGB eller Y/C (Ingen betydning)

\*1: NTSC/REMOTE/PAL-omskifteren skal sættes i stilling "PAL", når du tilslutter dvd-afspilleren via VIDEO-, S-VIDEO- eller AV OUT (SCART)-stikkene.

\*2: Signaler i NTSC-format sendes kun ud fra COMPONENT VIDEO OUT-jackstikkene.